



2024/1
CATALOGUE



Welcome to Dancop International GmbH



Dear customer,
Dear Sir or Madam,

Safety by quality is our motto. The success started in 1975 in a Danish town called Slangerup, when Jørgen Grynnerup started to manufacture industrial, traffic and safety mirrors made of synthetic material.

Logistics and sales are realized by Dancop International in Peine. The central position in Europe and the multilingual sales team provide perfect service.

We are happy to help you!

Nowadays, the company is successfully managed in the 2nd generation by Peter Grynnerup. The production progressed through the years by using latest technology.

Highest quality and highest safety standards are what we focus on. The same applies to our latest product group d-flex, launched in 2017.

The strengths of Dancop:

1. Innovation and development
2. Flexibility and fast delivery
3. High quality
4. Products fitting your demand
5. Customized items even in small series



<https://nagoya.hu/>
Any questions? Please call us
+36 24/526-026

d-flexx

FLEXIBLE IMPACT PROTECTION



- Flexible impact protection made in our own production
- The flexible material deforms upon impact and afterwards returns to its original shape
- For in- and outdoor use
- 100% recyclable
- Easy installation - fixing material included in the delivery
- Considerably minimizes maintenance costs
- Customized products for perfect fit

Product video



Scan me!

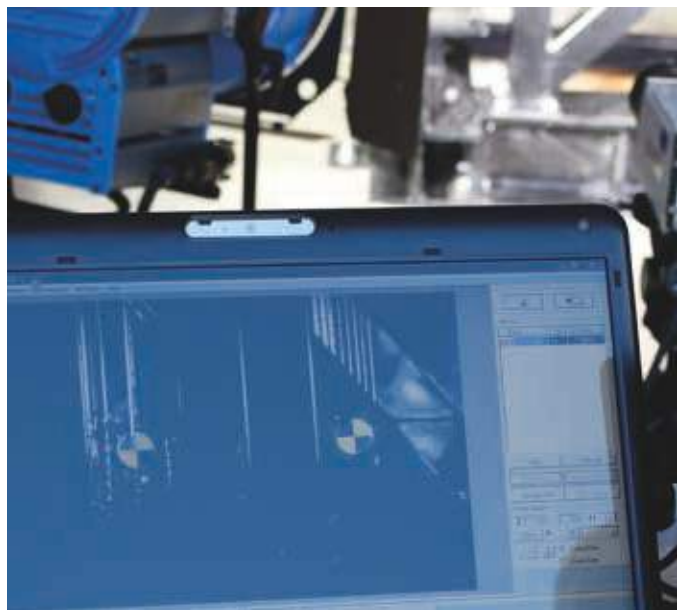



RACK GUARD "ALFA"

The rack guard "Alfa" from our d-flexx series is an innovative protection for shelves.

The easy installation allows for a quick application and fast annual rack inspections.

The rack guard is clicked directly onto the shelf, this way the floor remains undamaged in case of collisions.

TÜV-tested according to DIN EN 15512:2010-09, chapter 6.4.1 and DIN EN 15635:2009-08, chapter 9.5.1 with 400 joules.

The d-flexx rack protection "Alfa" is available in two different heights: 400 mm and 600 mm for rack legs 75-99 mm and 100-125 mm.

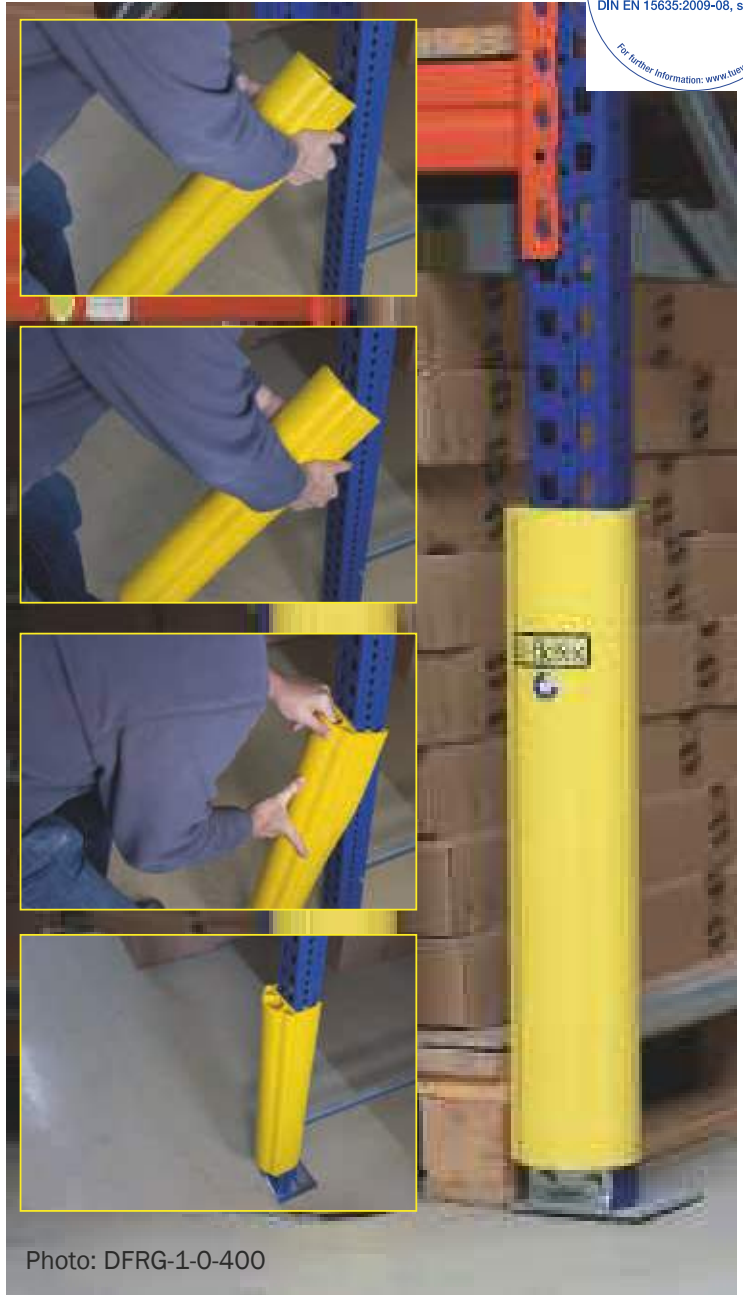
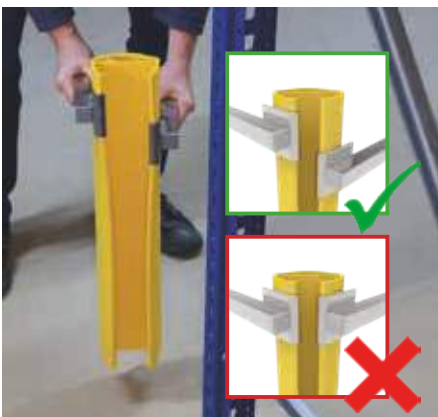

Photo: DFRG-1-0-400



Photo: DFRG-TOOL



Art. No.	Height	For rack legs	Weight
DFRG-1-0-400	400 mm	75 - 99 mm	1,1 kg
DFRG-2-0-400	400 mm	100 - 125 mm	1,3 kg
DFRG-1-0-600	600 mm	75 - 99 mm	1,6 kg
DFRG-2-0-600	600 mm	100 - 125 mm	1,9 kg
DFRG-TOOL	Set of 2 d-flexx ALFA assembly tools		



<https://nagoya.hu/>
Any questions? Please call us
+36 24/526-026

MODULAR

TRAFFIC BARRIER PLUS "ECHO"

The flexible traffic barrier plus "Echo" is a combination of the d-flexx modules "Charlie" and "Delta". The additional heavy pipe in the lower part of the traffic barrier provides extended protection in pedestrian areas.

The fixing material is included in the delivery.



Photo: DFVB-SP-2
Slider plate

Traffic barrier PLUS "Echo", made of polyethylene, post height 1.200 mm, base plate 225 x 225 mm

Art. No.	Description	Width	Weight
DFVB+E	End post	600 mm	17,0 kg
DFVB+M	Middle post	1000 mm	17,2 kg
DFVB+M+W90L	Echo on Delta corner post 90° left	600 mm	14,6 kg
DFVB+M+W90R	Echo on Delta corner post 90° right	600 mm	14,6 kg
DFVB+H1	Beam set: 3 beams, 1.510 mm, Ø 63 mm and 1 pipe 930 mm, Ø 160 mm		7,2 kg
DFVB+HI	Beam set: 3 beams, 980 - 1.510 mm, Ø 63 mm and 1 pipe 930 mm, Ø 160 mm		4,05 kg / m
DFVB-SP-2	Slider plate 330 x 240 mm, steel		3,2 kg



FLEXIBLE SAFETY BARRIER "DELTA"

The flexible safety barrier "Delta" is an innovative separation of pedestrian areas and driveways. Customized solutions can always be supplied.

The column protector "Delta" consists of four corner posts of the "Delta" safety barrier, which are connected with the associated spar sets to a square. The height of the column protection amounts to 1200 mm, the spar sets can be ordered in lengths of 705 mm and 1510 mm. Of course, the column protection "Delta" also offers the possibility of ordering individual lengths between 350 mm and 1510 mm.

The fixing material is included in the delivery.

Flexible safety barrier "Delta", made of polyethylene, post height 1.200 mm, post Ø 110 mm, base plate 150 x 150 mm

Art. No.	Description	Weight
DFFS-M-E	End post	8,0 kg
DFFS-M-M	Middle post	8,0 kg
DFFS-M-W90	90° corner post	8,0 kg
DFFS-M-T	T-post	8,0 kg
DFFS-M-K	Cross post	8,0 kg
DFFS-H1	Beam set: 3 beams, 1.510 mm	4,5 kg
DFFS-HI	Beam set: 3 beams, customized length 350-1.510 mm	3 kg / m
DFFS-B110	Bollard	8,7 kg
DFFS-M-W22.5	Corner post 22,5°	8,7 kg
DFFS-M-W45	Corner post 45°	8,7 kg
DFFS-M-W67.5	Corner post 67,5°	8,7 kg
DFFS-M-W292.5	Corner post 292,5°	8,7 kg
DFFS-M-W315	Corner post 315°	8,7 kg
DFFS-M-W337.5	Corner post 337,5°	8,7 kg
DFFS-SP-2	Mobile slider plate for 110 mm posts	2.04 kg



Customized items available ex works!



Photo: DFFS-SP-2
Mobile Plate

MODULAR

FLEXIBLE SAFETY BARRIER "DELTA"

In addition to the standard "Delta" safety barrier, we offer you the "Delta" barrier with four beams in height 1.200 mm. The „Delta“ barrier in 1.200 mm height with four beams offers even more protection with a distance of only 329 mm to the ground.

The fixing material is included in the delivery.



Photo: DFFS-SP-2
Mobile Plate

Flexible safety barrier "Delta", made of polyethylene, post Ø 110 mm, base plate 150 x 150 mm.

Description	Art. No.	Weight
End post	DFFS-M-4E	8,7 kg
Middle post	DFFS-M-4M	8,7 kg
90° corner post	DFFS-M-4W90	8,7 kg
T-post	DFFS-M-4T	8,7 kg
Cross post	DFFS-M-4K	8,7 kg
Beam set: 4 beams, 1.510 mm	DFFS-M-4H1	
Beam set: 4 beams, customized length 350-1.510 mm	DFFS-M-4HI	
Corner post 22,5°	DFFS-M-4W22.5	8,7 kg
Corner post 45°	DFFS-M-4W45	8,7 kg
Corner post 67,5°	DFFS-M-4W67.5	8,7 kg
Corner post 292,5°	DFFS-M-4W292.5	8,7 kg
Corner post 315°	DFFS-M-4W315	8,7 kg
Corner post 337,5°	DFFS-M-4W337.5	8,7 kg
DFFS-SP-2	Mobile slider plate for 110 mm posts	2.04 kg



Customized items available ex works!

TRAFFIC BARRIER SINGLE RAIL "CHARLIE"

The flexible d-flexx Traffic Barrier "Charlie" provides an optimal protection for machines, inventory and employees. Thanks to the easy and fast assembly in combination with individually cutted lengths, traffic routes can be separated quickly and easily from work areas or pedestrian paths.

Bollards are a useful addition at the end of the traffic barriers.

The fixing material is always included in the delivery.

Traffic barrier single rail „Charlie“, modular, height 516 mm, made of polyethylene, post Ø 200 mm, base plate 225 x 225 mm.

TÜV certified according to PAS 13: 2017 chapter 7/7.8 .



Art. No.	Description "Charlie"	Height	Weight
DFVB-E	End post	500 mm	12,8 kg
DFVB-M	Middle post	500 mm	13,6 kg
Art. No.	Description "Charlie"	Length	Weight
DFVB-R	Standard pipe Ø 160 mm	930 mm	2,6 kg
DFVB-I	Standard pipe Ø 160 mm	indivi. 400 - 929 mm	2,8 kg / m
DFVB-SP-2	Slider plate 330 x 240 mm, steel		3,2 kg



Customized items available ex works!



Photo: "Charlie"



MODULAR

TRAFFIC BARRIER DOUBLE RAIL "HOTEL"

The flexible d-flexx Traffic Barrier "Hotel" provides an optimal protection for machines, inventory and employees. Due to the double pipes and the additional higher posts, the area is more protected. Thanks to the easy and fast assembly in combination with individually cutted lengths, traffic routes can be separated quickly and easily from work areas or pedestrian paths.

Bollards are a useful addition at the end of the traffic barriers.

The fixing material is included in the delivery.

Traffic barrier double rail "Hotel", modular, height 760 mm, made of polyethylene, post Ø 200 mm, base plate 225 x 225 mm.

TÜV certified according to PAS 13: 2017 chapter 7/7.8 .



Art. No.	Description "Hotel"	Height	Weight
DFVBD-E	End post	706 mm	14,5 kg
DFVBD-M	Middle post	706 mm	15,9 kg
Art. No.	Description "Hotel"	Length	Weight
DFVBD-R	2 Standard pipes Ø 160 mm	930 mm	5,2 kg
DFVBD-I	2 Standard pipes Ø 160 mm	indivi. 2 x 400 - 929 mm	5,2 kg / m
DFVB-SP-2	Slider plate 330 x 240 mm, steel		3,2 kg



Photo: "Hotel"



TRAFFIC BARRIER "LIMA"

The flexible traffic barrier "Lima" is a combination of the d-flexx modules "Delta" and "Hotel". Due to the additional pipes in the lower part of the traffic barrier it is suitable for heavy duty traffic.

The fixing material is included in the delivery.

Traffic barrier "Lima", made of polyethylene, post height 1.200 mm, base plate 225 x 225 mm



Art. No.	Description	Width	Weight
DFDH-M-E	End post	600 mm	19,2 kg
DFDH-M-M	Middle post	1000 mm	20,9 kg
DFDH-M-H1	Beam set: 2 beams, 1.510 mm, Ø 63 mm and 2 pipes 930 mm, Ø 160 mm		9,5 kg
DFDH-M-HI	Beam set: 2 beams, 980-1.510 mm, Ø 63 mm and 2 pipes Ø 160 mm customized length		9,5 kg / m
DFVB-SP-2	Slider plate 330 x 240 mm, steel		3,2 kg



Customized items available ex works!



Photo: DFVB-SP-2
Slider plate

RACK END PROTECTION "GOLF"

The flexible rack-end barrier "Golf" protects rack ends both in- and outdoors.

Once installed, the rack end is not in contact with the rack. This allows the rack end protection to absorb impact energy.

Cost and time-consuming maintenance is reduced to a minimum. Furthermore, the moveable cuffs on the posts deflect impact energy.

The double rail version is for driveways with heavy pallet trucks.

The fixing material is included in the delivery.

Rack end protection "Golf", made of polyethylene, pipe Ø 160 mm, base plate 225 x 225 mm.

TÜV certified according to PAS 13: 2017 chapter 7/7.8 .



Art. No	Description	Width	Height	Weight
DFRE1-2	Rack end protection, single rail	1100 mm	500 mm	23,6 kg
DFRE1-4	Rack end protection, single rail	2500 mm	500 mm	26,2 kg
DFRE2-2	Rack end protection, double rail	1100 mm	706 mm	25,6 kg
DFRE2-4	Rack end protection, double rail	2500 mm	706 mm	28,6 kg



Before / during / after impact

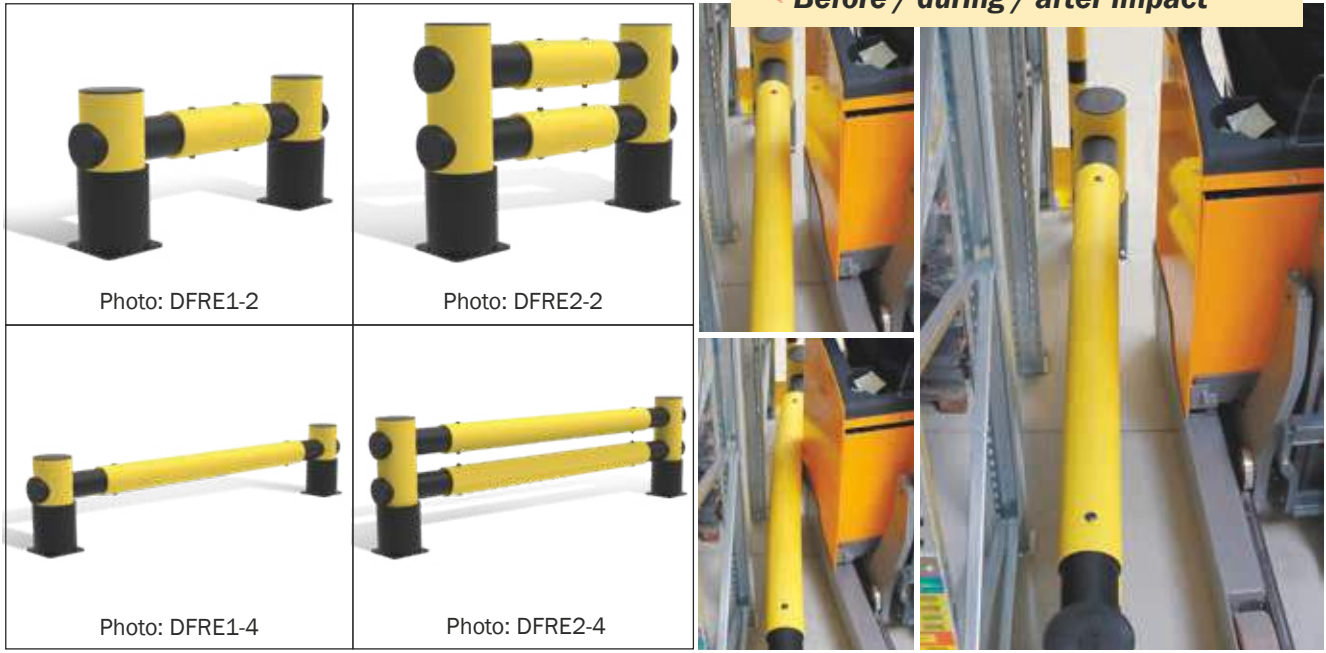

SWING GATE "JULIET"

The "Juliet" swing gate can be installed free-standing or as part of our modular "Delta" and "Echo" systems. „Juliet“ is made of polyethylene and can be opened up to 180 ° using hydraulic hinges. The robust and stable swing gate is a low-maintenance upgrade for your safety barriers. The stickers for visualization are used to quickly find the passage option within modular railings. The 800-1200 mm variants also have a self-closing mechanism, which further increases user comfort.

The mounting material is included in the delivery.

Art. No.	Description	Weight
DFJU+TM	Echo middle post for Juliet swing gate	12,8 kg
DFJU+TT	Echo T-post for Juliet swing gate	16,7 kg
DFJU+TW90L	Echo corner post 90° for Juliet swing gate left	15,7 kg
DFJU+TW90R	Echo corner post 90° for Juliet swing gate right	15,7 kg
DFJU+TE	Echo end post for Juliet swing gate	12,8 kg
DFJU-DA800-A	Juliet swing gate 800 mm	6,3 kg
DFJU-DA1000-A	Juliet swing gate 1000 mm	6, 7kg
DFJU-DA1200-A	Juliet swing gate 1200 mm	7,1 kg
DFJU-DA1500-A	Juliet swing gate 1500 mm with wheel	9,3 kg
DFJU-DA1750-A	Juliet swing gate 1750 mm with wheel	9, 8 kg
DFJU-DA2000-A	Juliet swing gate 2000 mm with wheel	10,3 kg
DFJU-HI-A	Juliet door hinge set, Version A	

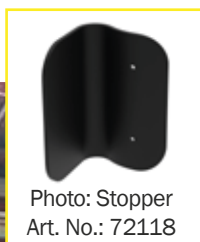

MODULAR

SWING GATE "JULIET"

The "Juliet" swing gate can be installed free-standing or as part of our modular "Delta" and "Echo" systems. „Juliet“ is made of polyethylene and can be opened up to 180 ° using hydraulic hinges. The robust and stable swing gate is a low-maintenance upgrade for your safety barriers. The stickers for visualization are used to quickly find the passage option within modular railings. The 800-1200 mm variants also have a self-closing mechanism, which further increases user comfort.

The mounting material is included in the delivery.

Art. No.	Description	Weight
DFJU-TM	Delta middle post for Juliet swing gate	12,8 kg
DFJU-TT	Delta T-post for Juliet swing gate	16,7 kg
DFJU-TW90L	Delta corner post 90° for Juliet swing gate left	15,7 kg
DFJU-TW90R	Delta corner post 90° for Juliet swing gate right	15,7 kg
DFJU-TE	Delta end post for Juliet swing gate	12,8 kg
DFJU-DA800-A	Juliet swing gate 800 mm	6,3 kg
DFJU-DA1000-A	Juliet swing gate 1000 mm	6,7kg
DFJU-DA1200-A	Juliet swing gate 1200 mm	7,1 kg
DFJU-DA1500-A	Juliet swing gate 1500 mm with wheel	9,3 kg
DFJU-DA1750-A	Juliet swing gate 1750 mm with wheel	9,8 kg
DFJU-DA2000-A	Juliet swing gate 2000 mm with wheel	10,3 kg
DFJU-HI-A	Juliet door hinge set, Version A	

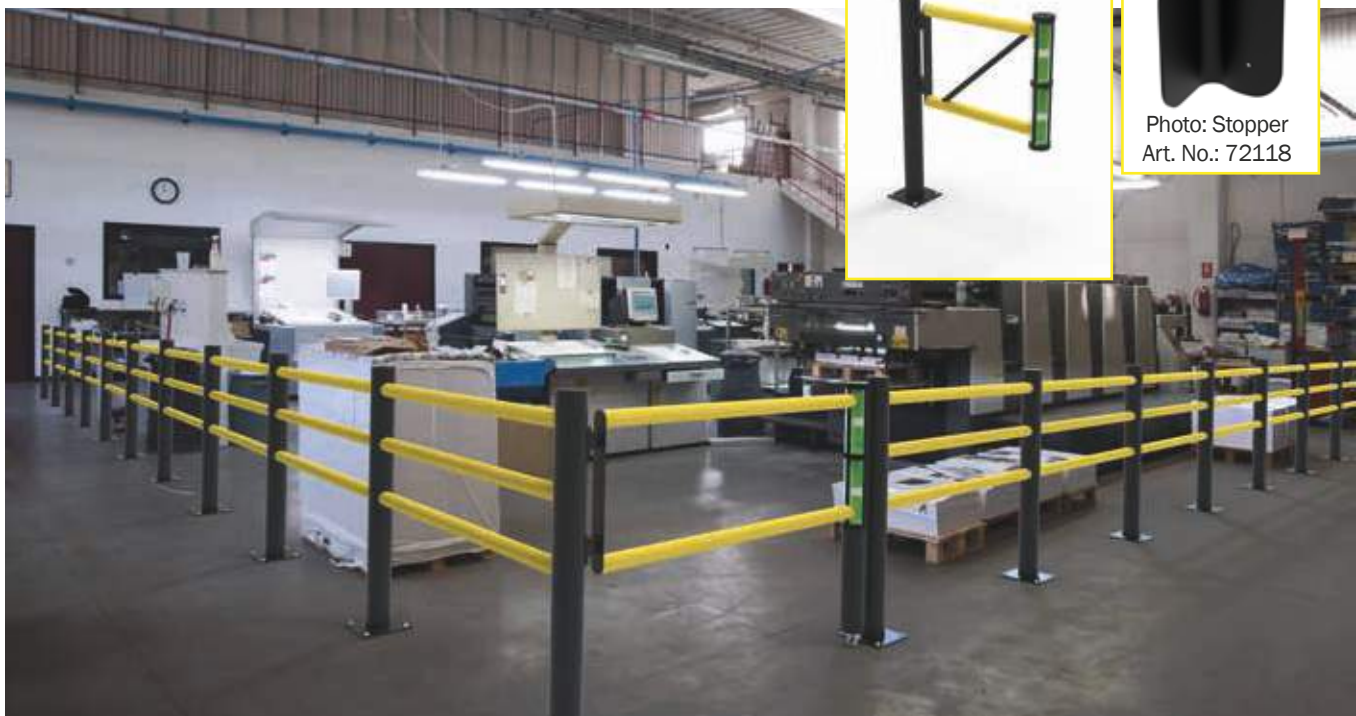

Photo: Stopper
Art. No.: 72118

SLIDE GATE "OSCAR"

The "Oscar" slide gate is the ideal solution for areas in which a swing gate cannot be used. "Oscar" is made of polyethylene and can be combined with our modular systems "Echo" and "Delta" (3 and 4 beams with a height of 1200 mm). "Oscar" can also be installed free-standing. The handles make "Oscar" very easy to operate and ensure safe access to the storage areas.

The mounting material is included in the delivery.

Art. No.	Description	Weight
DFOS-DFFS-1000	d-flexx Delta Oscar Sliding gate 1000 mm	22,3 kg
DFOS-DFFS-1200	d-flexx Delta Oscar sliding gate 1200 mm	44,3 kg
DFOS-DFFS-1500	d-flexx Delta Oscar sliding gate 1500 mm	24,9 kg
DFOS-4DFFS-1000	d-flexx Delta Oscar 4 sliding gate 1000 mm	44,4 kg
DFOS-4DFFS-1200	d-flexx Delta Oscar 4 sliding gate 1200 mm	45,6 kg
DFOS-4DFFS-1500	d-flexx Delta Oscar 4 sliding gate 1500 mm	47,5 kg
DFOS+DFVB+1000	d-flexx Echo Oscar sliding gate 1000 mm	57,4 kg
DFOS+DFVB+1200	d-flexx Echo Oscar sliding gate 1200 mm	59,2 kg
DFOS+DFVB+1500	d-flexx Echo Oscar sliding gate 1500 mm	61,9 kg

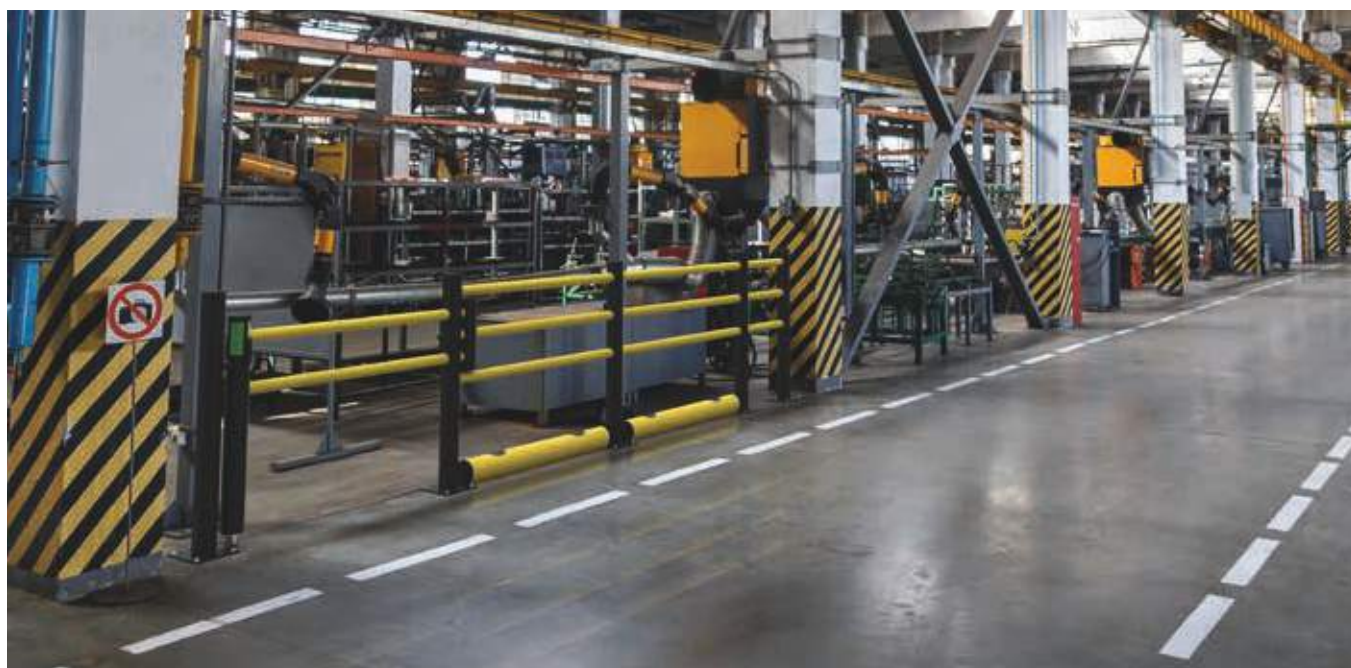
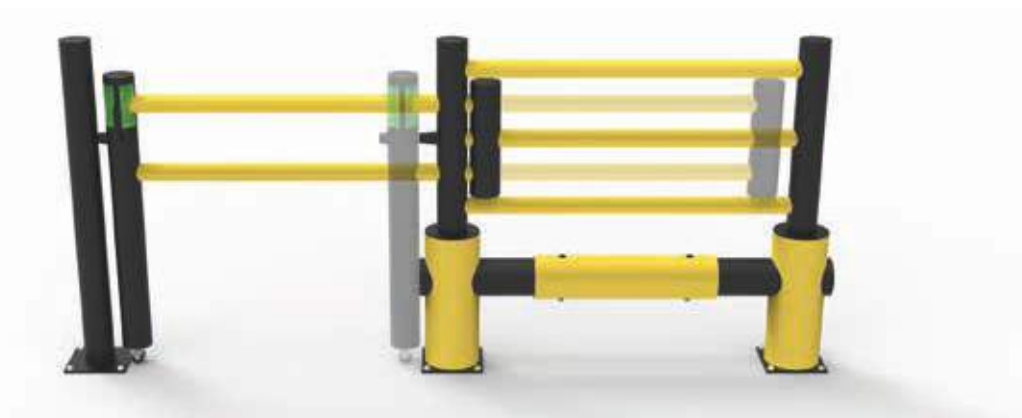

NEW**d-flexx**

DOCK GATE "NOVEMBER"

The flexible dock gate "November" provides safety in loading zones. During everyday use, the dock gate will convince you through its easy handling; it can be opened and closed by only one person. The built-in retaining spring prevents lowering or abrupt dropping of the tube which ensures a safe use. The combination with our other d-flexx products results in a complete barrier.

The fixing material is included in the delivery.

Art. No	Inside length	Total length	Width	Height	Weight
DFNO-W2300	2300 mm	2750 mm	585 mm	500 mm	56,2 kg
DFNO-W2600	2600 mm	3050 mm	585 mm	500 mm	58,3 kg
DFNO-WI	2300 - 3300 mm	2750 - 3750 mm	585 mm	500 mm	63,2 kg



UNDERRIDE GUARD "MIKE"

The flexible kerb barrier "Mike" is the ideal product to protect walls and assembly lines from collisions in floor area. Its round shape allows for a diversion of force in case of an impact. The kerb barrier "Mike" can be combined with most of the d-flexx series for a full safety solution.

As our other products, it is made from special material to absorb the impact force and return into its original shape. It is easily installed and a cost-effective way to prevent collisions.

The fixing material is always included in the delivery.
The height of the kerb barrier is 140 mm.



Art. No.	Description	Length	Weight
DFKB-1	Underride guard ø 140 mm	1300 mm	5,9 kg
DFKB-2	Underride guard ø 140 mm	2000 mm	8,5 kg
DFKB-3	Underride guard ø 140 mm	1500 mm	6,8 kg
DFKB-4	Underride guard ø 140 mm	1000 mm	4,9 kg
DFKB-5	Underride guard ø 140 mm	500 mm	3,2 kg
DFKB-I	Underride guard ø 140 mm	Customized length 400 - 1499 mm	6,6 kg
DFKB-I2	Underride guard ø 140 mm	Customized length 1501 - 1999 mm	8,5 kg



HANGING HEIGHT RESTRICTION "PAPA"

The flexible d-flexx height restriction "Papa" is the optimal solution for marking driveways, gates and other areas with low clearance heights. The robust construction enables long-term use in industry and thus reduces maintenance costs. The eye-catching colouring ensures increased attention. The pre-assembled product is mounted using the suspension device included in the scope of delivery, which can be attached to the ceiling or other components.

The fixing material is always included in the scope of delivery. 1500 and 2000mm.

Art. No.	Description	Length	Height / Width	Weight
DFPA-W1000	Height restriction	1000 mm	ø 140,5 mm	4,5 kg
DFPA-W1500	Height restriction	1500 mm	ø 140,5 mm	6,7 kg
DFPA-W2000	Height restriction	2000 mm	ø 140,5 mm	8,45 kg



Photo: DFPA-W1000

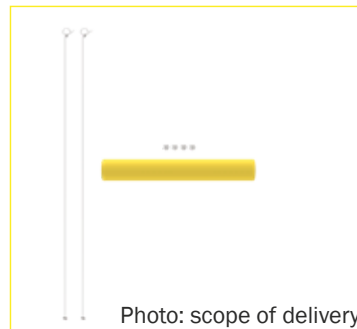

Photo: scope of delivery



Photo: DFPA-W2000



MACHINE PROTECTION FENCE "FOXTROT"

The flexible d-flexx machine protection fences "Foxtrot" are the fast and easy way to separate working areas and routes from each other. This product is delivered already pre-assembled and can be installed without further assembly activities.

The outer sides are provided with an additional handrail seal to extend the protection area.

The fixing material is always included in the delivery.

Machine protective fencing „Foxtrot“ is made of polyethylene, height 1.200 mm, pre-mounted, with base plate 150 x 150 mm

Art. No.	Description "Foxtrot"	Width	Weight
DFFS-FU1	Machine protection fence	1000 mm	17,0 kg
DFFS-FU2	Machine protection fence	1500 mm	19,0 kg
DFFS-FU3	Machine protection fence	2000 mm	22,0 kg
DFFS-SP-2	Mobile slider plate for 110 mm posts		2,04 kg



Photo: DFFS-FU1



Photo: DFFS-SP-2
Mobile Plate

Photo: "Foxtrot"



MACHINE PROTECTION FENCE "KILO"

The flexible d-flexx machine protection fence "Kilo" is a fast and easy way to separate work areas and routes. This product is delivered pre-assembled and can be installed without further assembly. The outer sides are equipped with additional handrails to further extend the protection area.

The fixing material is included in the delivery.

Machine protective fencing "Kilo" is made of polyethylene, height 1.200 mm, pre-mounted, with base plate 225 x 225 mm

Art. No.	Description "Kilo"	Width	Weight
DFKI+FU1	Machine protection fence	1000 mm	41,1 kg
DFKI+FU2	Machine protection fence	1500 mm	44,5 kg
DFKI+FU3	Machine protection fence	2000 mm	47,4 kg
DFVB-SP-2	Slider plate, steel	330 x 240 mm	3,2 kg



Photo: DFVB-SP-2
Slider plate



Photo: DFKI+FU1



Photo: "Kilo"



FLEXIBLE BOLLARD "BRAVO"

The flexible d-flex bollard "Bravo" absorbs the impact energy. The special material prevents damage to both ground and vehicle. Due to its robustness and high visibility, the bollard is the ideal product for protecting inventory and employees. An additional version featuring a revolving cuff complements the series.

The d-flex-Bollards "Bravo" are available in heights of 516 mm, 760 mm, and 1.200 mm.

The fixing material is included in the delivery.

Bollard "Bravo", made of polyethylene, with base plate 225 x 225 mm

TÜV certified according to PAS 13: 2017 chapter 7/7.8 .

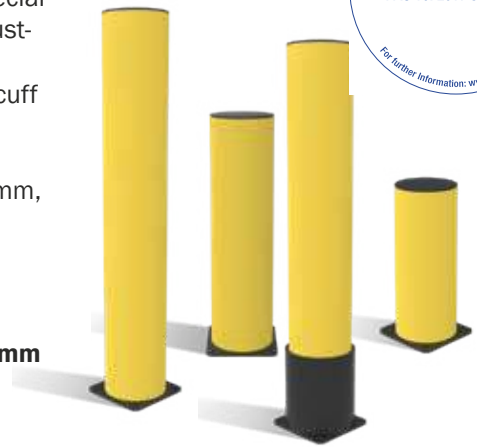

Art. No.	Description	Height	Pipe diameter	Weight
DFB050-10	Bollard	1200 mm	ø 200 mm	15,5 kg
DFB050-20	Bollard	760 mm	ø 200 mm	12,5 kg
DFB050-40	Bollard	500 mm	ø 200 mm	10,8 kg
DFB050-30	Bollard with rotatable cuff	1200 mmm	ø 225 mm	15,9 kg
DFVB-SP-2	Slider plate 330 x 240 mm, steel			3,2 kg



Photo: DFVB-SP-2
Slider plate



<https://nagoya.hu/>
Any questions? Please call us
+36 24/526-026



Storage and transport racks, loading safety



Guardrail



Impact protection made of steel



Storage rack for barriers



Parking security



Impact protection corners



L- and U-Profiles



Park stops



Column protection

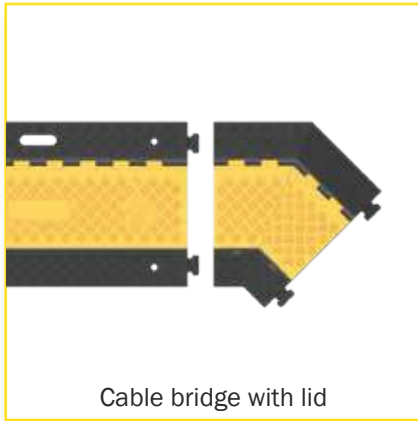

Cable bridge with lid





Steel

MODULAR SAFETY RAILING

This modular safety railing can be put together as per your needs.

Made of steel, galvanized and powder coated for outdoor use or only powder coated for indoor use.

Color: traffic yellow, like RAL 1023



other RAL colors available



Customized versions possible!



Beams for safety railing, cross section 80 x 140 mm, fixing material for beams included in the delivery.

Length	Art. No. indoor use	Art. No. outdoor use	Weight
50 cm	B-50	B+50	6,0 kg
75 cm	B-75	B+75	9,5 kg
100 cm	B-100	B+100	11,0 kg
120 cm	B-120	B+120	13,5 kg
135 cm	B-135	B+135	13,8 kg
150 cm	B-150	B+150	14,2 kg
200 cm	B-200	B+200	22,0 kg

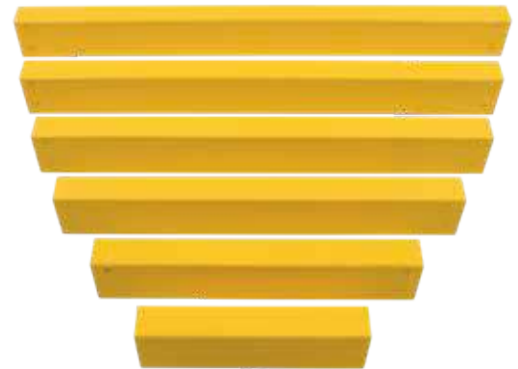

Posts for safety railing, cross section 100 x 100 mm, base plate 200 x 200 mm, mounting via 4 drill holes Ø 12,5 mm

Description	Post 50 cm		Weight	Post 100 cm		Weight
	Art. No. indoor use	Art. No. outdoor use		Art. No. indoor use	Art. No. outdoor use	
End post	PE-50	PE+50	8,0 kg	PE-100	PE+100	14,0 kg
Middle post	PM-50	PM+50	10,0 kg	PM-100	PM+100	15,0 kg
Corner post	PW-50	PW+50	10,0 kg	PW-100	PW+100	15,7 kg
Single post				P-100	P+100	12,6 kg
Floor anchor 85 mm, galvanized, Art. No. FIX 1						
Floor anchor set of 4 pieces Art. No. FIX 4						

Photo:
end post,
middle post,
corner post
height 50 cm



Photo:
end post, middle
post, corner post
single post height
100 cm





Steel

POST WITH REMOVAL BRACKETS

The posts with removal pockets of the modular TÜV-certified (compliant with DGUV 108-007 / previously BGR 234) safety railing are used in areas where temporary access for maintenance work is necessary. The beams are inserted

into the tabs and can be removed by hand without additional tools. The tabs are processed to protect the coating to ensure a long service life.



Photo: PEE-100



Photo: PME-100



Photo: PWE-100



Photo: PMES-100

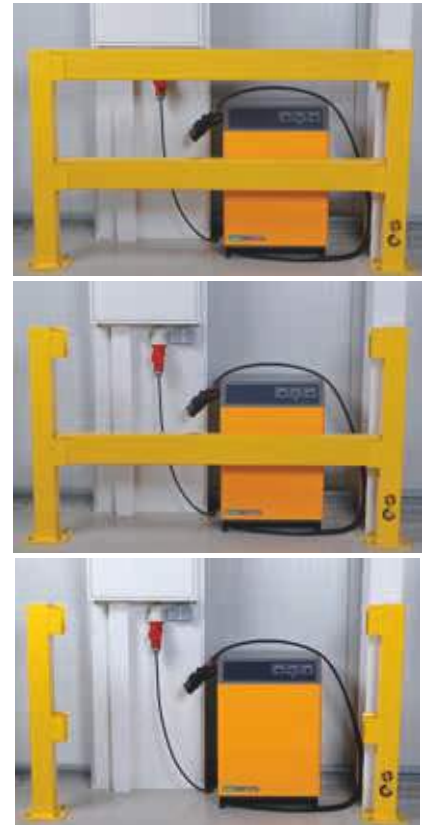

other RAL colors available



Customized versions possible!



Posts with removal brackets, steel, cross section 100 x 100 mm, powder coated for indoor use, yellow (like RAL 1023), base plate 200 x 200 mm, mounting via 4 drill holes Ø 12,5 mm, TÜV-certified

Art. No.	Description	Weight
PEE-100	End post with removal bracket	13,5 kg
PME-100	Middle post with removal brackets on both sides	14,5 kg
PWE-100	Corner posts with removal bracket	14,5 kg
PMES-100	Middle post with removal bracket on one side, and permanent connection on the other	15,0 kg
FIX 4	Floor anchor 85 mm galvanized set of 4 pieces	



Photo: unilateral removal bracket



Photo: removal bracket

<https://nagoya.hu/>
Get more information by email
nagoya@nagoya.hu





Steel

SWING GATE

The swing gate for the TÜV-certified (compliant with DGUV 108-007 / previously BGR 234) safety barrier is an effective solution to secure passageways. Due to the bent construction the swing gate is highly visible, even in longer sections.

The swing gate closes automatically to ensure a safe traffic flow and to minimize the risk of accidents.

The swing gate can also be placed within already existing safety barrier systems.



other RAL colors available



Customized versions possible!



We do your planning! info@dancop.com



90° opening, self-closing



Art. No.: SWTSG-PE



Photo: Art. No.: SWTWM

Swing gate, steel, self-closing, including 2 middle posts, width entire element 1.070 mm, height 1.000 mm, width swing gate 870 mm, height swing gate element 200 mm, distance floor to lower pipe 760 mm. Delivery pre-installed. Powder coated for indoor use, yellow (like RAL 1023), base plate 200 x 200 mm, mounting via 4 drill holes 12,5 mm.

Art. No.	Description	Total width	Passage width max.	Weight
SWTSG-	Swing gate	1070 mm	870 mm	33,2 kg
SWTWM	Swing gate for wall mounting, indoor use only	870 mm	782 mm	6,5 kg
SWTSG-PE	Swing gate with end post	1070 mm	850 mm	38 kg
FIX 8	Floor anchor 85 mm galvanized set of 8 pieces			



<https://nagoya.hu/>
Any questions? Please call us
+36 24/526-026



other RAL colors available



Customized versions possible!



Steel

SLIDE GATE

The Slide Gate for the TÜV-certified (compliant with DGUV 108-007 / previously BGR 234) Safety Barrier Steel is a safe solution to secure passageways up to 3 m. The slide gate for the TÜV-certified (compliant with DGUV 108-007 / previously BGR 234) safety barrier Steel is a safe solution to secure passageways up to 3 m. With the slide mechanism the slide gate can be easily opened, the gate parts do not block the passageway. When opening the gate, the cross braces slip into the beam set which allows safe and easy access. With the double-sided handle the gate can be easily opened and closed.

The slide gate comes pre-assembled and can be used free-standing, in combination with a slampost (Art. No. P-100, page 14) or in combination with a customized version of the TÜV-certified (compliant with DGUV 108-007 / previously BGR 234) safety barrier system.

When planning a modular system, the end post which is included in the delivery, will be placed at the end of the safety barrier, and is replaced by a middle or corner post.



Slide Gate, height 1.000 mm, one unit consisting of: 2 end posts 1.000 x 100 x 100 mm, 2 beams 1.500 x 140 x 80 mm, 1 slide gate with a handle 1.000 mm, total width 2.760 mm, maximum passage width 1.000 mm, powder coated for indoor use, yellow (like RAL 1023), base plate 200 x 200 mm, floor mounting via 4 drill holes Ø 12,5 mm, TÜV-certified (compliant with DGUV 108-007 / previously BGR 234).

Art. No.	Description	Total width	Passage width	Weight
SBTSG-100	Slide gate	2760 mm	1000 mm	72,8 kg
SBTSG-150	Slide gate	3760 mm	1500 mm	86,3 kg
FIX 8	Floor anchor 85 mm galvanized set of 8 pieces			

With 2 gates 1,5 m: maximum passage width 3,0 m possible!

Photo: 2 x Art. No. SBTSG-150

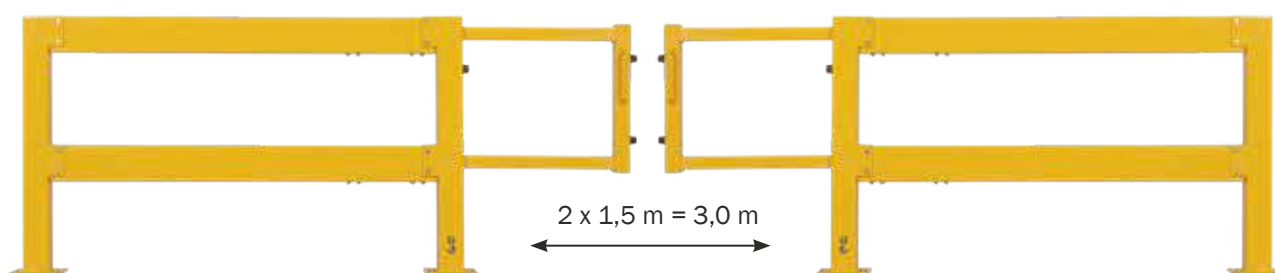



Steel

EXPANSION MODULES

The TÜV-certified (compliant with DGUV 108-007 / previously BGR 234) add-on modules for the safety barrier help increase safety and avoid damages and injuries in logistic and production areas.

The add-on modules can be integrated in new or already existing Dancop safety barriers. The reach-through and the anderride guard (page 20) help close the front of the safety barrier thereby preventing accidents.

The wall bracket allows to fix the safety barrier on the wall, the magnet and the magnetic tape cartridge perfectly complete the assortment.



TÜV-certified for you!
(compliant with DGUV 108-007 / previously BGR 234)



other RAL colors available



Customized versions possible!



ANDERRIDE GUARD

Anderride guard for safety barrier, height 490 mm, to be attached to the lower beam, powder coated for indoor use, yellow (like RAL 1023) with black warning stripes, TÜV-certified (compliant with DGUV 108-007 / previously BGR 234).

Art. No.	Description	Weight
UFSSG-50	Length 380 mm	8,5 kg
UFSSG-100	Length 880 mm	19,4 kg
UFSSG-120	Length 1080 mm	24,0 kg
UFSSG-135	Length 1230 mm	27,4 kg
UFSSG-150	Length 1380 mm	30,8 kg
UFSSG-200	Length 1880 mm	42,0 kg



<https://nagoya.hu/>
Any questions? Please call us
+36 24/526-026



other RAL colors available



Customized versions possible!



MAGNETIC RETRACTABLE BARRIER



Retractable strap, 50 mm wide, magnetic end and magnetic fixing, with acrylic housing, maximum extension length 4.600 mm, diagonal stripes, 3 fixation magnets with 90 N holding force each, housing 118 x 143 x 85 mm



Art. No.	Color band	Color holder	Length	Weight
MGB-GS	Yellow-black	Yellow-black	4600 mm	1,0 kg
MGB-RW	Red-white	Red-black	4600 mm	1,0 kg

WALL BRACKET

The wall bracket is a cost-effective solution for fixing beams of the safety barrier on walls or other levelled surfaces. Screws and dowels for wall mounting are not included in the delivery.

Wall bracket for safety barrier, 120 x 110 x 60 mm, galvanized and powder coated for outdoor use, yellow (like RAL 1023), TÜV-certified (compliant with DGUV 108-007 / previously BGR 234)

Art. No.	Description	Size	Weight
WSG+	Wall bracket	110 x 120 x 60 mm	1,5 kg
WSGE+	Wall bracket with removal tabs	110 x 120 x 60 mm	1,5 kg



Art. No.: WSG+



Art. No.: WSGE+

MAGNET WITH HOOK - ADHESIVE FORCE APPROX. 30 KG

The hook magnet is a quick and easy way for installing chains on steel surfaces. The corresponding chain set is available separately.

Hook magnet with M5 internal thread, total height 48 mm, magnet height 8 mm, Ø total 32 mm, Ø pin 10 mm, tolerance +/-0.1 mm, magnet with neodymium alloy, magnetisation/level N38, nickel-plated, adhesive force approx. 30 kg, max. operation temperature 80°

Art. No.	Description	Height	Weight
TOMA+ZIH	Magnet with hook	48 mm	0,1 kg





Steel

SAFETY BARRIER Ø 48 MM

The safety barrier made of steel with a pipe Ø 48 mm is a great solution to separate drive- and pathways. The yellow and black coloring ensures high visibility.

With the different parts, including the unique variable post with a rotation angle of up to 270°, any conceivable design can be realized.

The individual components of this modular safety barrier are simply plugged together. The fixing material for floor mounting can be ordered separately.



other RAL
colors
available



Customized
versions
possible!



Posts for safety barrier, Ø 48 mm, 2,9 mm material thickness, galvanized and powder coated for outdoor use, yellow (like RAL 1023), with black warning stripe, base plate 150 x 100 x 6 mm, floor mounting via 4 drill holes Ø 10 mm.

Art. No.	Description	Weight
E-SG	End post 1000 x 250 mm	5,4 kg
W-SG	Corner post 1000 x 500 / 250 mm	7,4 kg
M-SG	Middle post 1000 x 500	7,2 kg
FIX 4	Floor anchor 85 mm galvanized set of 4 pieces	

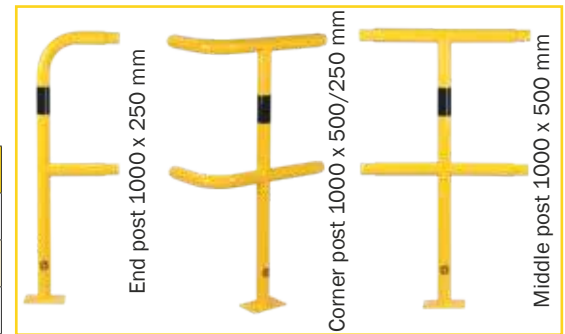

Modular corner post for safety barrier, Ø 60 mm, height 1.000 mm, 270° rotatable, 2,9 mm material thickness, galvanized and powder coated for outdoor use, yellow (like RAL 1023) with black warning stripe, base plate 150 x 100 x 6 mm, floor mounting via 4 drill holes Ø 10 mm.

Art. No.	Description	Base plate	Weight
VE-SG	Modular corner post 1000 x 250 x 250 mm	150 x 100 x 6 mm	12,5 kg
FIX 4	Floor anchor 85 mm galvanized set of 4 pieces		



Beam for safety barrier, Ø 48,3 mm, 2,9 mm material thickness, galvanized and powder coated for outdoor use, yellow (like RAL 1023) with black warning stripe.

Art. No.	Description	Weight
RH-SG 50	Beam 500 mm	1,6 kg
RH-SG 100	Beam 1000 mm	3,2 kg
RH-SG 150	Beam 1500 mm	4,8 kg



<https://nagoya.hu/>
Any questions? Please call us
+36 24/526-026



other RAL colors available



Customized versions possible!



Steel

EXPANDING BARRIERS

Our TÜV-certified (compliant with DGUV 108-007 / previously BGR 234) expanding barriers are made of steel and perfect for quickly closing off dangerous areas. Available colors: red-white version with double side reflecting foil and yellow black.

The expanding barriers allow space-saving storage. They are available in versions with feet, wheels, or wall bracket.

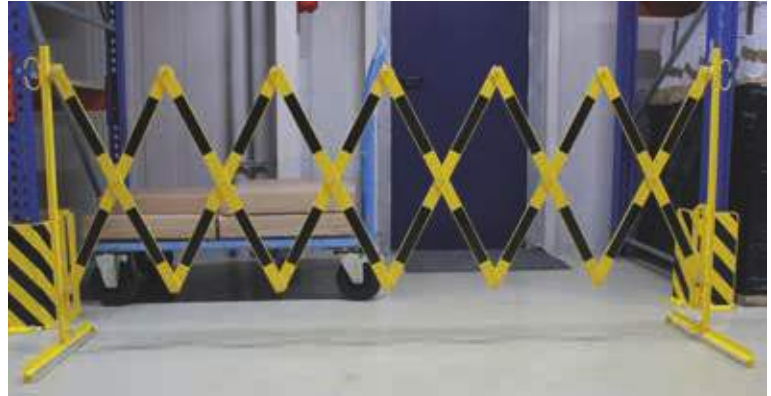
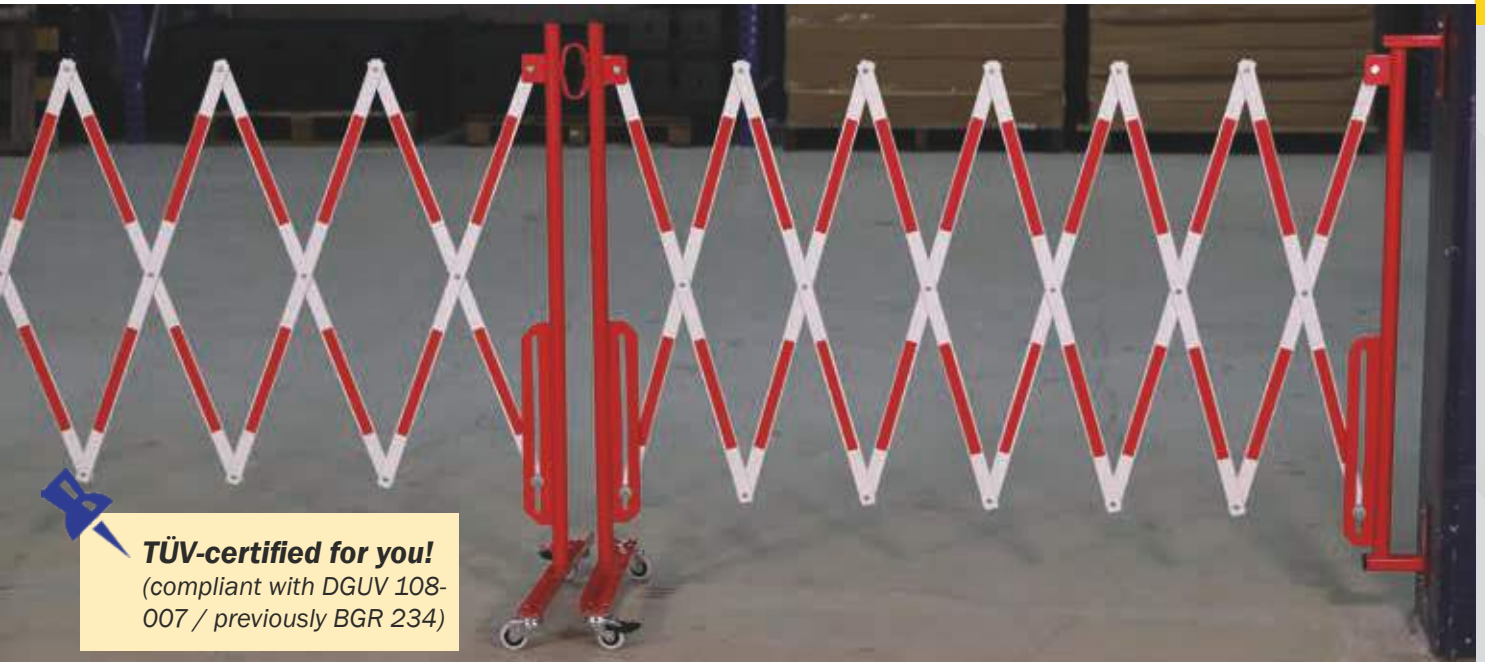

Photo: Art. No. 70-40



TÜV-certified for you!
(compliant with DGUV 108-007 / previously BGR 234)

Expandable to 3,6 m oder 4,0 m

Photo: Art. No. 70-10W

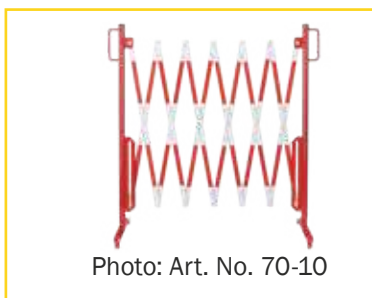

Photo: Art. No. 70-10

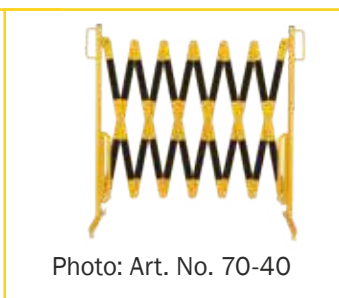

Photo: Art. No. 70-40

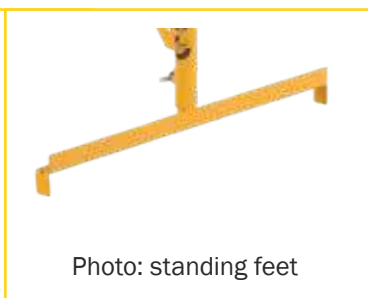

Photo: standing feet



Photo: Art. No. BL

Expanding barriers, steel, height 1.050 mm, with feet on both sides, powder coated for indoor use, red-white version with reflecting foil on both sides, TÜV-certified (compliant with DGUV 108-007 / previously BGR 234).

Art. No.	Width	Color	Folded width total	Material flat steel	Weight
70-10	3600 mm	red-white	ca. 335 mm	4 x 25 mm	13,1 kg
70-20	4000 mm	red-white	ca. 430 mm	5 x 40 mm	20,3 kg
70-30	3600 mm	yellow-black	ca. 335 mm	4 x 25 mm	13,1 kg
70-40	4000 mm	yellow-black	ca. 430 mm	5 x 40 mm	21,1 kg
BL	Access protection for expanding barriers. With 2 keys.				0,15 kg

<https://nagoya.hu/>
Get more information by email
nagoya@nagoya.hu





other RAL colors available



Customized versions possible!



Steel

EXPANDING BARRIERS WITH CASTERS

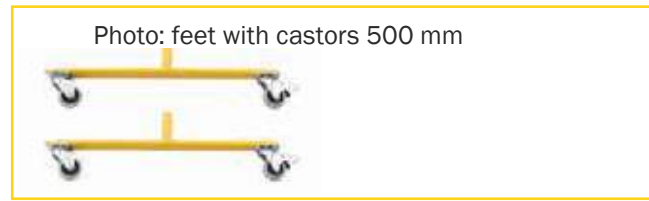
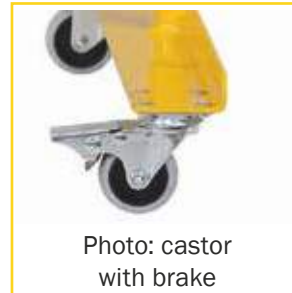

Expanding barriers, steel, height 1.050 mm, with casters on both sides, powder coated for indoor use, red-white version with reflecting foil on both sides, TÜV-certified (compliant with DGUV 108-007 / previously BGR 234).

Art. No.	Width	Color	Folded width total	Castors	Material flat steel	Weight
70-10R	3600 mm	red-white	ca. 335 mm	yes	4 x 25 mm	14,6 kg
70-20R	4000 mm	red-white	ca. 430 mm	yes	5 x 40 mm	22,2 kg
70-30R	3600 mm	yellow-black	ca. 335 mm	yes	4 x 25 mm	14,6 kg
70-40R	4000 mm	yellow-black	ca. 430 mm	yes	5 x 40 mm	22,2 kg
BL	Access protection for expanding barriers. With 2 keys.					0,15 kg

EXPANDING BARRIER WITH CASTERS AND WALL BRACKET

Expanding barriers, steel, height 1.050 mm, with castors on one side and wall bracket on the other, powder coated for indoor use, red-white version with reflecting foil on both sides, TÜV-certified (compliant with DGUV 108-007 / previously BGR 234).

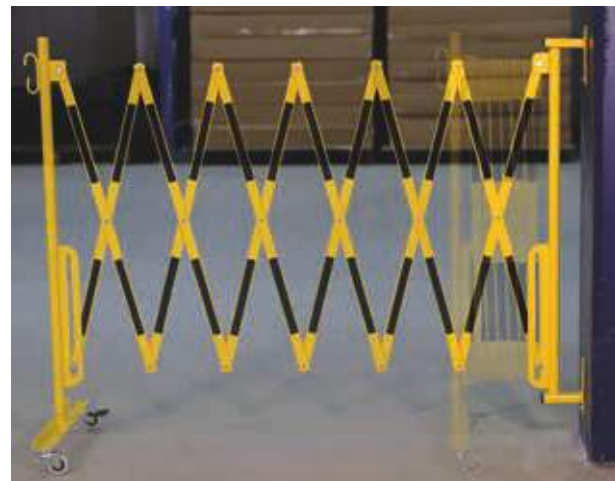
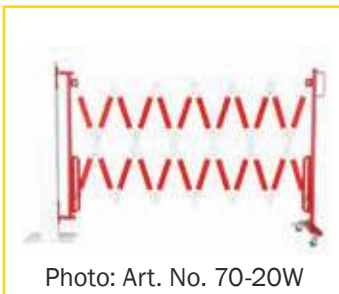

Art. No.	Width	Color	Folded width total	Castors	Material flat steel	Weight
70-10W	3600 mm	red-white	ca. 300 mm	yes	4 x 25 mm	14,3 kg
70-20W	4000 mm	red-white	ca. 390 mm	yes	5 x 40 mm	21,6 kg
70-30W	3600 mm	yellow-black	ca. 300 mm	yes	4 x 25 mm	14,3 kg
70-40W	4000 mm	yellow-black	ca. 390 mm	yes	5 x 40 mm	21,6 kg
BL	Access protection for expanding barriers. With 2 keys.					0,15 kg



<https://nagoya.hu/>
Any questions? Please call us
+36 24/526-026



other RAL colors available



Customized versions possible!



Steel

EXPANDING BARRIER WITH POST

The steel post version can be positioned in areas where the wall bracket is not an option.

Like the TÜV-certified (compliant with DGUV 108-007 / previously BGR 234) expanding barriers with wall bracket, these sets are available in yellow-black and red-white in standard lengths of 3.6 m and 4.0 m. The steel barrier posts are available with rectangular posts 70 x 70 mm or round posts Ø 60 mm. For temporary use, the round barrier post can also be combined with a mobile base plate.



Photo: Art. No. 70-100

Expanding Barrier with post and casters, steel, height 1.050 mm, powder coated for indoor use, base plate 195 x 120 mm, floor mounting via 4 drill holes Ø 12,5 mm, TÜV-certified (compliant with DGUV 108-007 / previously BGR 234).

Art. No.	Post	Color	Expanding barrier	Width	Folded width total	Weight
70-55	Ø 60 mm	red-white	Flat steel 25 x 4 mm	3600 mm	ca. 400 mm	17,4 kg
70-60	Ø 60 mm	red-white	Flat steel 40 x 5 mm	4000 mm	ca. 490 mm	24,0 kg
70-65	Ø 60 mm	yellow-black	Flat steel 25 x 4 mm	3600 mm	ca. 400 mm	17,4 kg
70-70	Ø 60 mm	yellow-black	Flat steel 40 x 5 mm	4000 mm	ca. 490 mm	24,0 kg
70-95	70 x 70 mm	red-white	Flat steel 25 x 4 mm	3600 mm	ca. 410 mm	17,4 kg
70-100	70 x 70 mm	red-white	Flat steel 40 x 5 mm	4000 mm	ca. 500 mm	24,4 kg
70-105	70 x 70 mm	yellow-black	Flat steel 25 x 4 mm	3600 mm	ca. 410 mm	17,4 kg
70-110	70 x 70 mm	yellow-black	Flat steel 40 x 5 mm	4000 mm	ca. 500 mm	24,4 kg
BL	Access protection for expanding barriers. With 2 keys.					0,15 kg

Steel

EXPANDING BARRIER WITH HEAVY FOOT PLATE

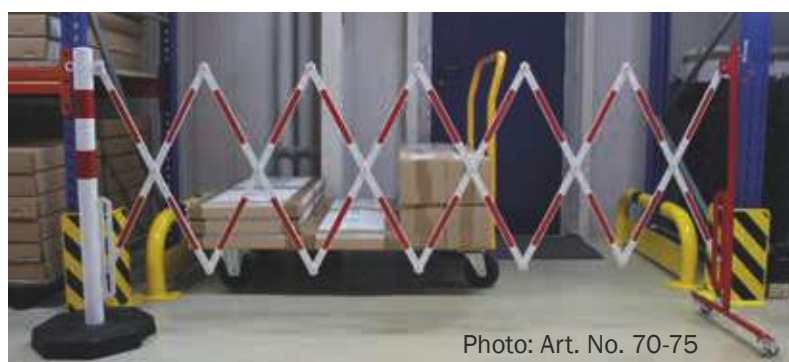

Photo: Art. No. 70-75



Photo: Art. No. 70-90

Expanding Barrier with heavy foot plate and casters, steel, height 1.050 mm, powder coated for indoor use, mobile foot plate for posts Ø 60 mm, TÜV-certified (compliant with DGUV 108-007 / previously BGR 234).

Art. No.	Post	Color	Expanding barrier	Width	Folded width total	Weight
70-75	Ø 60 mm	red-white	Flat steel 25 x 4 mm	3600 mm	ca. 490 mm	22,7 kg
70-80	Ø 60 mm	red-white	Flat steel 40 x 5 mm	4000 mm	ca. 620 mm	30,0 kg
70-85	Ø 60 mm	yellow-black	Flat steel 25 x 4 mm	3600 mm	ca. 490 mm	22,7 kg
70-90	Ø 60 mm	yellow-black	Flat steel 40 x 5 mm	4000 mm	ca. 620 mm	30,0 kg
BL	Access protection for expanding barriers. With 2 keys.					0,15 kg





Steel

EXPANDING BARRIER SETS

These massive expanding barrier sets in lengths of 4 m or 16 m provide high stability without the need for floor mounting. The TÜV-certified (compliant with DGUV 108-007 / previously BGR 234) expanding barriers can be used to temporarily close off access points and areas.

They are easily handled due to ball bearings, handles and self-locking nuts. The individual elements can be connected via a retaining rod; besides, an information board can be added.



other RAL colors available



Customized versions possible!

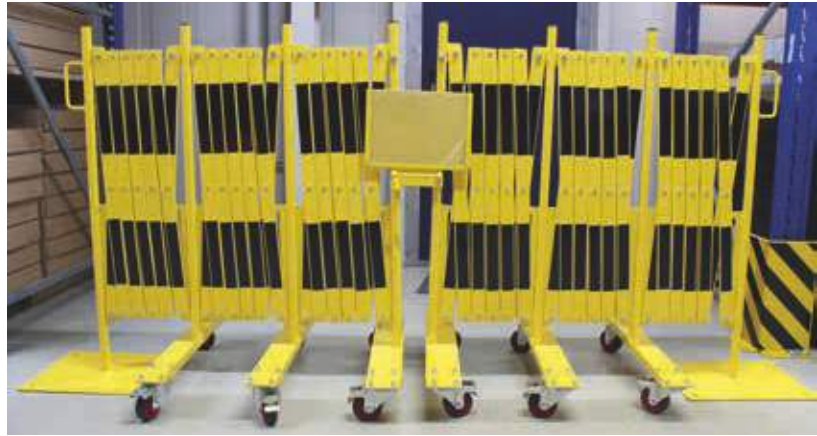

Photo: Art. No. 70-130

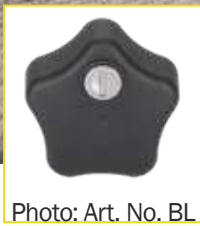

Photo: Art. No. BL

TÜV-certified for you!
(compliant with DGUV 108-007 / previously BGR 234)

Photo: Art. No. 70-115

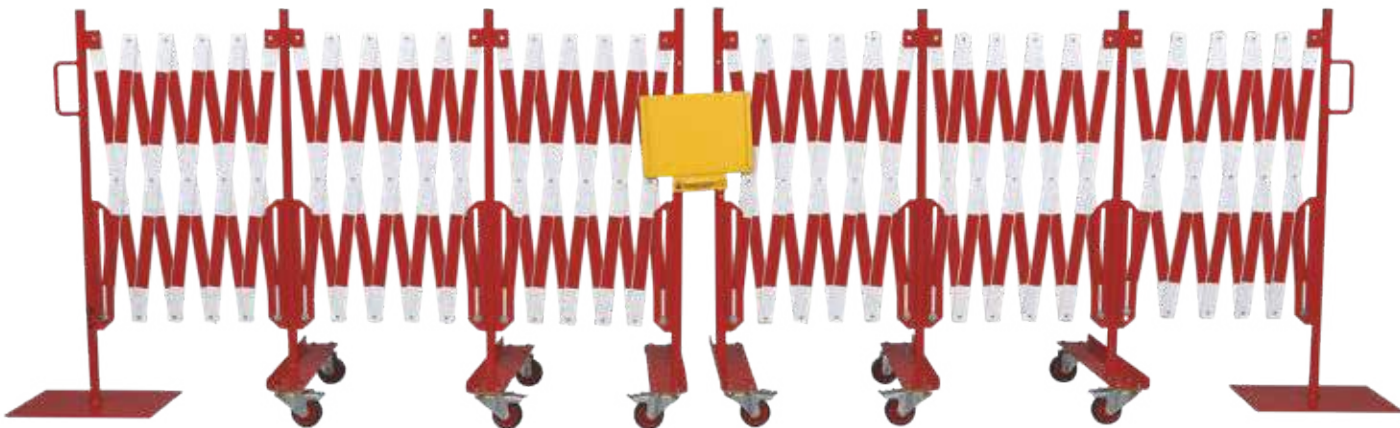

Photo: Art. No. 70-120

Expanding Barrier Set HEAVY DUTY, steel, height 1.050 mm, galvanized and powder coated for outdoor use, base plates 400 x 300 x 6 mm, heavy duty casters with brakes, side handles, retaining rod, steel document holder, TÜV-certified (compliant with DGUV 108-007 / previously BGR 234).

Art. No.	Description	Folded width total	Weight
70-115	Expanding barrier, 2 x 2000 mm, galvanized and powder coated, red-white	ca. 1160 mm	54,0 kg
70-125	Expanding barrier, 2 x 2000 mm, galvanized and powder coated, yellow-black	ca. 1160 mm	54,0 kg
70-120	Expanding barrier, 2 x 8000 mm, galvanized and powder coated, red-white	ca. 2340 mm	128,0 kg
70-130	Expanding barrier, 2 x 8000 mm, galvanized and powder coated, yellow-black	ca. 2340 mm	128,0 kg
BL	Access protection for expanding barriers. With 2 keys.		0,15 kg



<https://nagoya.hu/>
Any questions? Please call us
+36 24/526-026



other RAL colors available



Customized versions possible!



Steel

EXPANDING BARRIER KIT



Photo: Art. No. KIT 70-65

Expanding barrier kit with fixing bracket for mounting on already existing posts, delivery excl. post, expanding barrier with casters and brake, height 1.050 mm, TÜV-certified (compliant with DGUV 108-007 / previously BGR 234)

Art. No.	Post	Color	Expanding barrier	Width	Folded width total	Weight
KIT 70-60	ø 60 mm	red-white	Flat steel 40 x 5 mm	4000 mm	ca. 430 mm	21,9 kg
KIT 70-65	ø 60 mm	yellow-black	Flat steel 25 x 4 mm	3600 mm	ca. 335 mm	14,4 kg
KIT 70-105	70 x 70 mm	yellow-black	Flat steel 25 x 4 mm	3600 mm	ca. 345 mm	14,4 kg
BL	Access protection for expanding barriers. With 2 keys.					0,15 kg



TÜV-certified for you! (compliant with DGUV 108-007 / previously BGR 234)

Expanding barrier kit yellow-black (for mounting on already existing posts 100 x 100 mm, safety barrier), expanding barrier with casters and brake, height 1.050 mm, TÜV-certified (compliant with DGUV 108-007 / previously BGR 234).

Art. No.	Expanding barrier	Width	Folded width total	Weight
KIT SG 70-30	Flat steel 25 x 4 mm	3600 mm	ca. 335 mm	15,1 kg
KIT SG 70-40	Flat steel 40 x 5 mm	4000 mm	ca. 430 mm	22,1 kg
BL	Access protection for expanding barriers. With 2 keys.			0,15 kg

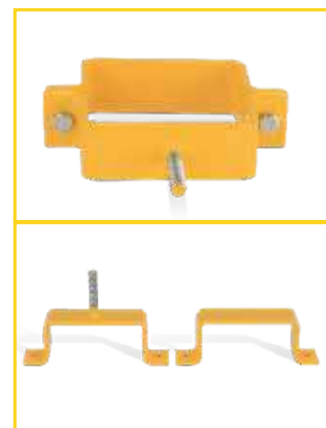

Photos: fixing bracket

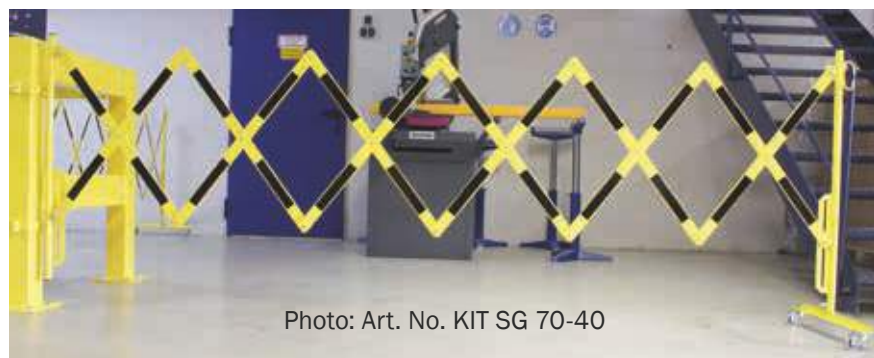

Photo: Art. No. KIT SG 70-40

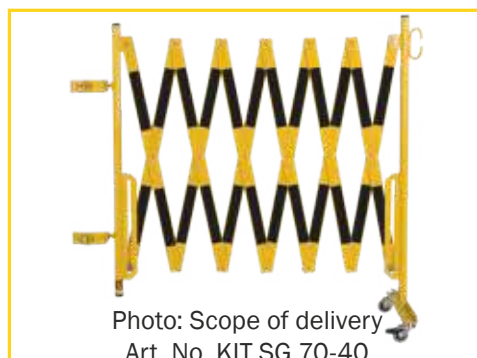

Photo: Scope of delivery Art. No. KIT SG 70-40





Steel

IMPACT PROTECTION STEEL

The steel impact protection products are made of high-grade steel and facilitate the effective protection of inventory, machines, and buildings both outdoors and indoors. Hazardous areas are clearly marked due to the combination of yellow coating and black warning stripes.

Beams and hoop guards are available in Ø 76 mm. The hoop guards are formed using the latest bending technology therefore there are no weld seams!

The bollards are available in Ø 76 mm, 88.9 mm, and 159 mm.

The product is fixed via floor anchors which are available separately.

The hoop guards with anderride protection are a perfect addition for sensitive areas that require special protection. They are available in a variety of types and measures to facilitate finding the right product.



other RAL colors available



Customized versions possible!



TÜV-certified for you!
(compliant with DGUV 108-007 / previously BGR 234)



Hoop protection guard, Ø 76 mm, galvanized and powder coated for outdoor use or powder coated for indoor use, yellow (like RAL 1023) with black warning stripes, material thickness 3,2 mm, base plate 120 x 195 mm, floor mounting via 8 drill holes Ø 12,5 mm, TÜV-certified (compliant with DGUV 108-007 / previously BGR 234).



Art. No. powder coated	Art. No. galvanized and powder coated	Height	Width	Weight
30-10-	30-10	350 mm	420 mm	6,9 kg
30-20-	30-20	350 mm	750 mm	8,5 kg
30-30-	30-30	350 mm	1000 mm	10,1 kg
30-40-	30-40	600 mm	750 mm	11,5 kg
30-50-	30-50	600 mm	1000 mm	13,0 kg
30-60-	30-60	1200 mm	750 mm	18,5 kg
30-70-	30-70	1200 mm	1000 mm	20,0 kg
Floor anchor 85 mm galvanized set of 8 pieces Art. No. FIX 8				

Hoop guard with anderride protection, Ø 76 mm, powder coated for indoor use, yellow (like RAL 1023) with black warning stripes, material thickness 3,2 mm, base plate 120 x 195 mm, floor mounting via 8 drill holes Ø 12,5 mm, TÜV-certified (compliant with DGUV 108-007 / previously BGR 234).



Art. No.	Height	Width	Height anderride guard	Weight
30-20-U	350 mm	750 mm	150 mm	11,4 kg
30-30-U	350 mm	1000 mm	150 mm	13,0 kg
30-40-U	600 mm	750 mm	400 mm	18,0 kg
30-50-U	600 mm	1000 mm	400 mm	24,1 kg
Floor anchor 85 mm galvanized set of 8 pieces Art. No. FIX 8				



<https://nagoya.hu/>
Any questions? Please call us
+36 24/526-026



TÜV-certified for you!
(compliant with DGUV 108-007 / previously BGR 234)



Impact protection beam, Ø 76 mm, galvanized and powder coated for outdoor use, yellow (like RAL 1023) with black warning stripes, material thickness 3,2 mm, base plate 120 x 195 mm, floor mounting via 8 drill holes Ø 12,5 mm, TÜV-certified.



Art. No.	Description	Weight
60-10	Length 400 mm	4,3 kg
60-20	Length 800 mm	6,6 kg
60-30	Length 1200 mm	8,9 kg
FIX 8	Floor anchor 85 mm galvanized set of 8 pieces	

Impact protection bollard, galvanized and powder coated for outdoor use, yellow (like RAL 1023) with black warning stripes, base plate 120 x 195 mm, floor mounting via 4 drill holes Ø 12,5 mm, TÜV-certified.



Art. No.	Diameter	Base plate	Material thickness	Weight
50-10	Ø 76 mm	120 x 195 mm	3,2 mm	8,3 kg
50-25	Ø 89 mm	140 x 195 mm	3,6 mm	9,9 kg
50-40	Ø 159 mm	240 x 240 mm	4,5 mm	23,4 kg
FIX 4	Floor anchor 85 mm galvanized set of 4 pieces			

Art. No.	Diameter	Concrete setting	Material thickness	Weight
50-20	Ø 76 mm	1200 mm	3,2 mm	9,4 kg
50-30	Ø 159 mm	1200 mm	4,5 mm	27,8 kg

Impact corner protection, arms 600 mm, Ø 76 mm, material thickness 3,2mm, base plate 120 x 195 mm, floor mounting via 12 drill holes Ø 12,5 mm, TÜV-certified.



Art. No. powder coated	Art. No. galvanized and powder coated	Height	Weight
40-10-	40-10	350 mm	12,9 kg
40-20-	40-20	600 mm	17,5 kg
40-30-	40-30	1200 mm	27,9 kg
Floor anchor 85 mm galvanized Art. No. FIX 1			
Floor anchor 85 mm galvanized set of 4 pieces Art. No. FIX 4			





Steel

MODULAR WALL PROTECTION

The modular wall protection system made of steel is the perfect solution to secure logistic areas. The different components meet the requirements of any local condition. Due to the variety of straight elements and in- or outside corners, endangered building sections are easily protected. Fixing material is available separately.

Modular wall protection, straight, Ø 76 mm, height 140 mm, galvanized and powder coated for outdoor use or powder coated for indoor use, yellow (like RAL 1023), base plate 120 x 195 x 6 mm, floor mounting via 4 drill holes Ø 12,5 mm, TÜV-certified (compliant with DGUV 108-007 / previously BGR 234).

Art. No. powder coated	Art. No. galvanized and powder coated	Length	Width	Weight
80-500-	80-500	500 mm	180 mm	5,5 kg
80-1000-	80-1000	1000 mm	180 mm	10,4 kg

Floor anchor 85 mm galvanized set of 4 pieces Art. No. FIX 4 / 1 piece Art. No. FIX 1



Photo: Art. No. 80-500



Photo: Art. No. 80-1000

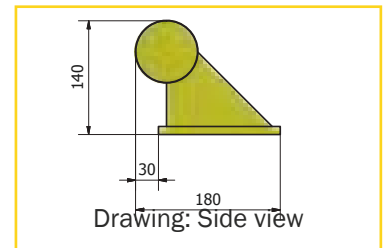

Drawing: Side view



Photo: left inner corner protection

TÜV-certified for you!

Modular wall protection, inner corner

Ø 76 mm, height 140 mm, galvanized and powder coated for outdoor use or powder coated for indoor use, yellow (like RAL 1023), base plate 120 x 195 x 6 mm, floor mounting via 4 drill holes Ø 12,5 mm, TÜV-certified.

Description	Corner 90° right, inside		Corner 90° left, inside	
	Lenght 500 mm Art. No.	Lenght 1000 mm Art. No.	Lenght 500 mm Art. No.	Lenght 1000 mm Art. No.
Powder coated	80-500WRI-	80-1000WRI-	80-500WLI-	80-1000WLI-
Galvanized and powder coated	80-500WRI	80-1000WRI	80-500WLI	80-1000WLI
Weight	5,6 kg	11,3 kg	5,6 kg	11,3 kg
Drawing				

Modular wall protection, outer corner

Ø 76 mm, height 140 mm, galvanized and powder coated for outdoor use or powder coated for indoor use, yellow (like RAL 1023), base plate 120 x 195 x 6 mm, floor mounting via 4 drill holes Ø 12,5 mm, TÜV-certified

Description	Corner 90° right, outside		Corner 90° left, outside	
	Lenght 500 mm Art. No.	Lenght 1000 mm Art. No.	Lenght 500 mm Art. No.	Lenght 1000 mm Art. No.
Powder coated	80-500WRA-	80-1000WRA-	80-500WLA-	80-1000WLA-
Galvanized and powder coated	80-500WRA	80-1000WRA	80-500WLA	80-1000WLA
Weight	5,4 kg	10,9 kg	5,4 kg	10,9 kg
Drawing				



<https://nagoya.hu/>
Any questions? Please call us
+36 24/526-026



TÜV-certified for you!
(compliant with DGUV 108-007 / previously BGR 234)



Steel

CRASH PROTECTION GUARD

The TÜV-certified (compliant with DGUV 108-007 / previously BGR 234) CrashStop rack protectors are designed according to the German Berufsgenossenschaft regulation in the L-form. These are required at the corner supports of fixed racks in order to protect the racks from collisions. The articles are marked with a yellow / black warning mark and are dimensioned accordingly to legal requirements. Further variants, like the U-shape for the middle rack legs, complete the assortment with different heights. If required, these articles can also be produced according to special customer requirements.



other RAL colors available



Customized versions possible!



Crash protection guards, height 400 mm, material thickness 5 mm, powder coated for indoor use, yellow (like RAL 1023), with black warning stripes, floor mounting via 4 drill holes Ø 15 mm, TÜV-certified (compliant with DGUV 108-007 / previously BGR 234).

Art. No.	Description	Weight
6260	L-profile 180 x 180 mm	6,1 kg
6250	U-profile inside 125 mm	6,4 kg
6255	U-profile XL inside 160 mm	7,0 kg
FIX 1	Ground anchor for collision protection	
FIX 4	Floor anchor 85 mm galvanized set of 4 pieces Art. No. FIX 4	



Special sizes possible from 1 piece!



<https://nagoya.hu/>
Get more information by email
nagoya@nagoya.hu





Polyethylene

COLUMN PROTECTION

Our column protection is a safeguard for posts and columns. Without any tools or floor mounting, the column protection can be installed by one person within seconds using reinforced velcro fasteners. The column protection is suitable for indoor and outdoor use. The Column protectors

30110, 30120 and 30130 come with reflective warning stripes. The velcro fasteners are included in the delivery.

Column protection made of polyethylene, height 1.000 mm

Art. No.	For columns	Outer size	Weight
30140	100 x 100 mm	435 x 390 mm	14,0 kg
30150	150 x 150 mm	435 x 390 mm	14,0 kg

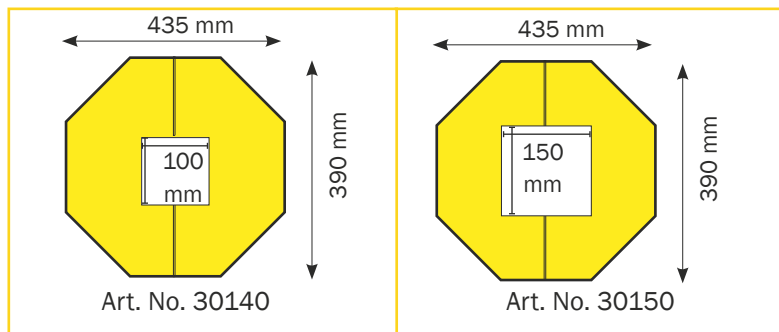

Photo: Art. No. 30150

Column protection made of polyethylene, height 1.100 mm, with two retro-reflecting warning stripes

Art. No.	For columns	Diameter	Weight
30110	160 x 160 mm	ø 620 mm	20,5 kg
30120	210 x 210 mm	ø 620 mm	17,0 kg
30130	260 x 260 mm	ø 620 mm	17,0 kg

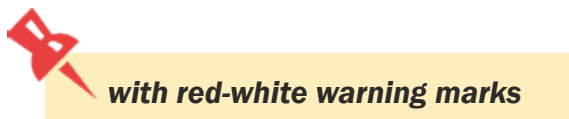
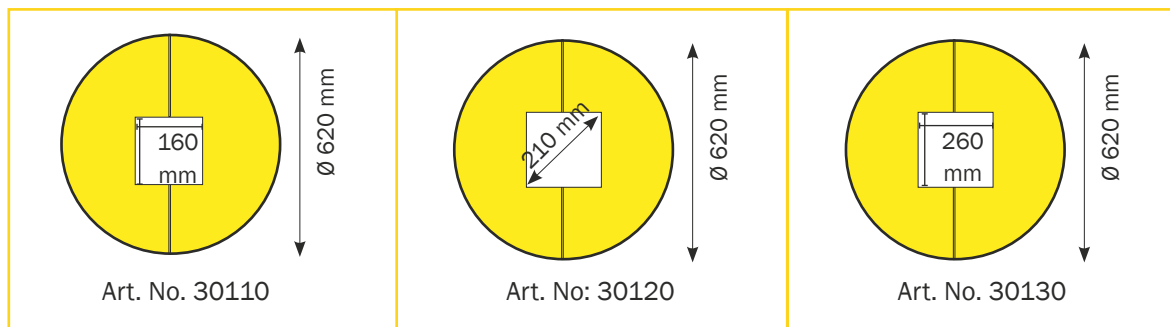

Photo: Art. No. 30110



<https://nagoya.hu/>
Any questions? Please call us
+36 24/526-026



Polyethylene

MODULAR COLUMN PROTECTION

The modular column protector is an effective solution to protect posts both in- and outside. It is made of shock-resistant polyethylene and suitable for columns with side lengths of 200-700 mm. It can be cut to size as per requirement. Floor mounting is not required, so the protector is easily removed without any residue. The installation can be carried out by one person.

Column protection made of polyethylene, 1.000 mm

Art. No.	Description	For columns	Height	Weight
30610	Column protection	200 - 700 mm	1000 mm	20,0 kg



Photo: Cutting marks in mm

Photo: Art. No. 30610

Polyethylene

NEW

COLUMN PROTECTION

Art. No.	Description	For columns	Height	Weight
SSG-PE	Column protection	100 x 100 mm	1000 mm	1,44 kg

This product amazes with its double benefit. The high visibility warning marking provides good visualisation of the critical area and cushions a possible collision with the sharp edges of steel supports or metal uprights. Thus, inventory, industrial trucks and employees are on the safe side. No tools or fastening materials are required for assembly. The 360° protection encloses the entire component and is fixed in place with Velcro. This is also protected by the hard-wearing surface. This means that the column protection can also be removed again without any problems or damage to the substrate.





Steel

STEEL POST PROTECTION

The post protector is a perfect solution for posts of up to 400 x 400 mm both in- and outdoors. The yellow-black warning stripes increase the visibility. The product is installed via base plates.

Post and column protection, for posts of 400 x 400 mm max., 2 parts 600 x 520 mm, galvanized and powder coated for outdoor use or powder coated for indoor use, yellow (like RAL 1023), base plate 160 x 70 mm, floor mounting via 8 drill holes Ø 12,5 mm, TÜV-certified (compliant with DGUV 108-007 / previously BGR 234).

Art. No. powder coated	Art. No. galvanized and powder coated	Height	Width	Weight
SRR-500-	SRR-500	600 mm	520 mm	16,6 kg
Floor anchors 85 mm galvanized set of 8 pieces Art. No. FIX 8				



consists of two parts

TÜV-certified for you!
(compliant with DGUV 108-007 / previously BGR 234)

Steel

CRASH PROTECTION GUARD FOR PIPES AND CABLES

These protective elements ensure solid protection for pipes of up to Ø 200 mm indoors and outdoors. The different measures combined with the yellow-black warning colors gives the perfect solution for protecting pipes and help reduce maintenance.

TÜV-certified for you!
(compliant with DGUV 108-007 / previously BGR 234)

Protection for pipes and cables up to Ø 200 mm, 300 x 230 mm (inside width 290 mm), galvanized and powder coated for outdoor use, yellow (like RAL 1023) with black warning stripes, wall mounting, TÜV-certified (compliant with DGUV 108-007 / previously BGR 234).



Art. No. powder coated	Art. No. galvanized and powder coated	Height	Inside width	Depth	Flap	Weight
RS-500-	RS-500	500 mm	290 mm	230 mm	50 mm	9,1 kg
RS-1000-	RS-1000	1000 mm	290 mm	230 mm	50 mm	18,3 kg



<https://nagoya.hu/>
Any questions? Please call us
+36 24/526-026



Steel

IMPACT PROTECTION FOR LONG PALLETS

The impact protection for long pallets is the best solution for protecting goods which protrude into pathways. It is easily employed without any additional mounting. The impact protection is fixed by the weight of the pallet and easily removed. The yellow-black warning colors ensure high visibility.

Impact protection for long pallets, 860 x 400 mm, cut-out size 620 x 300 mm, powder coated for indoor use, yellow (like RAL 1023), with black warning stripes

Art. No.	Description	Weight
6270	Impact protection for long pallets, width 860 mm, arm length 200 mm, height 400 mm, cut-out 620 x 300 mm	14,0 kg

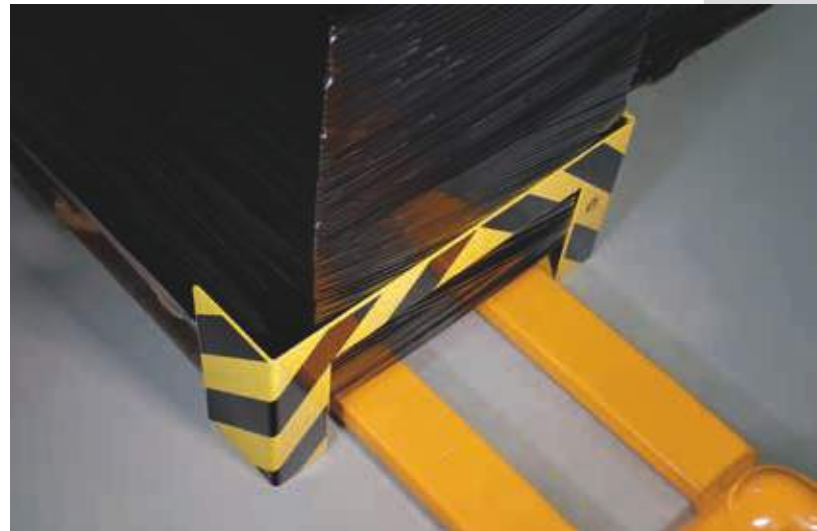



Steel

BARRIER POST AND ACCESSORIES

The barrier posts and sets of chain posts are the most effective solution to mark hazardous areas in- and outdoors. The different versions, Ø 60 mm or 70 x 70 mm, enable a wide range of applications. Barrier posts for floor mounting, concrete setting or ground sleeves are available in yellow-black and red-white. The fixing material is available separately.



other RAL
colors
available



Customized
versions
possible!



TÜV-certified for you!
(compliant with DGUV 108-007 / previously BGR 234)

BARRIER POSTS WITH EYELETS



Photo: Art. No. 20-10+OESEN and 20-00-1

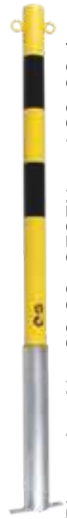

Photo: Art. No. 20-20+OESEN and 20-00-1



Photo: Art. No. 20-30+OESEN and 20-00-2



Photo: Art. No. 20-40+OESEN and 20-00-2



Photo: Art. No. 20-50+OESEN



Photo: Art. No. 20-60+OESEN



Photo: Art. No. 20-70+OESEN



Photo: Art. No. 20-80+OESEN

Art. No.	Description	Weight
Post with eyelets to set in concrete, steel, galvanized and powder coated, height 1.400 mm, with ground sleeve, white post with red reflecting foil, TÜV-certified, Round iron ground anchor included		
20-10+OESEN and 20-00-1	Round post with eyelets, red-white Ø 60 mm and ground sleeve	8,4 kg
20-20+OESEN and 20-00-1	Round post with eyelets, yellow-black Ø 60 mm and ground sleeve	8,4 kg
20-30+OESEN and 20-00-2	Square post with eyelets, red-white, 70 x 70 mm and ground sleeve	9,2 kg
20-40+OESEN and 20-00-2	Square post with eyelets, yellow-black, 70 x 70 mm and ground sleeve	9,2 kg
Post with eyelets to set in concrete, steel, powder coated, height 1.400 mm, Round iron ground anchor included		
20-10+OESEN-	Round post with eyelets, red-white, Ø 60 mm	5,5 kg
20-30+OESEN-	Square post with eyelets, red-white, 70 x 70 mm	7,7 kg
Post with eyelets, base plate 120 x 195 mm, floor mounting via 4 drill holes Ø 12,5 mm steel, powder coated, height 1.000 mm		
20-50+OESEN-	Round post with eyelets, red-white, Ø 60 mm	5,1 kg
20-70+OESEN-	Square post with eyelets, red-white, 70 x 70 mm	7,1 kg
Post with eyelets, steel, galvanized and powder coated, height 1.000 mm, white post with red reflecting foil, base plate 120 x 195 mm, floor mounting via 4 drill holes Ø 12,5 mm, TÜV-certified		
20-50+OESEN	Round post with eyelets, red-white, Ø 60 mm	5,1 kg
20-60+OESEN	Round post with eyelets, yellow-black, Ø 60 mm	5,3 kg
20-70+OESEN	Square post with eyelets, red-white, 70 x 70 mm	5,6 kg
20-80+OESEN	Square post with eyelets, yellow-black, 70 x 70 mm	5,6 kg
FIX 4	Floor anchors 85 mm galvanized set of 4 pieces	



<https://nagoya.hu/>
Any questions? Please call us
+36 24/526-026



Steel BARRIER POSTS



other RAL
colors
available



Customized
versions
possible!



TÜV-certified for you!
(compliant with DGUV 108-007 / previously BGR 234)



Art. No.	Description	Weight
Post to set in concrete, galvanized and powder coated, steel, height 1.400 mm, with ground sleeve, white post with red reflecting foil, TÜV-certified, Round iron ground anchor included		
20-10 and 20-00-1	Round post, red-white Ø 60 mm and ground sleeve	8,4 kg
20-20 and 20-00-1	Round post yellow-black Ø 60 mm and ground sleeve	8,4 kg
20-30 and 20-00-2	Square post, red-white, 70 x 70 mm and ground sleeve	9,1 kg
20-40 and 20-00-2	Square post, yellow-black, 70 x 70 mm and ground sleeve	9,1 kg
Post to set in concrete, powder coated, steel, height 1.400 mm, Round iron ground anchor included		
20-10-	Round post, red-white, Ø 60 mm	5,5 kg
20-30-	Square post, red-white, 70 x 70 mm	6,1 kg
Post with eyelets, base plate 120 x 195 mm, floor mounting via 4 drill holes Ø 12,5 mm steel, powder coated, height 1.000 mm		
20-50-	Round post, red-white, Ø 60 mm	5,2 kg
20-70-	Square post, red-white, 70 x 70 mm	5,5 kg
Post, steel, galvanized and powder coated, height 1.000 mm, white post with red reflecting foil, base plate 120 x 195 mm, floor mounting via 4 drill holes Ø 12,5 mm, TÜV-certified		
20-50	Round post, red-white, Ø 60 mm	5,2 kg
20-60	Round post, yellow-black, Ø 60 mm	5,2 kg
20-70	Square post, red-white, 70 x 70 mm	5,5 kg
20-80	Square post, yellow-black, 70 x 70 mm	5,5 kg
FIX 4	Floor anchors 85 mm galvanized set of 4 pieces	





Steel

BARRIER POSTS AND ACCESSORIES



other RAL colors available



Customized versions possible!



Art. No.	Description	Weight
Round barrier posts with eyelets and mobile base plate, total height 1000 mm		
10-10-1 and MPF	Round barrier post, with eyelets, yellow-black, Ø 60 mm, height 1000 mm and mobile base plate	10,5 kg
10-20-1 and MPF	Round barrier post, with eyelets, red-white, Ø 60 mm, height 1000 mm and mobile base plate	10,5 kg
Round barrier posts with eyelets and knock-in ground socket in set, height above floor 1000 mm, total height 1500 mm		
10-10	Barrier post yellow-black and impact ground sleeve	8,6 kg
10-20	Barrier post red-white reflective and impact ground sleeve	8,6 kg



<https://nagoya.hu/>
Any questions? Please call us
+36 24/526-026



Steel BARRIER POSTS AND ACCESSORIES



other RAL
colors
available



Customized
versions
possible!

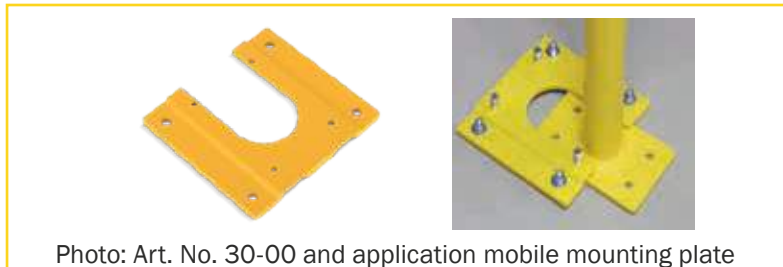
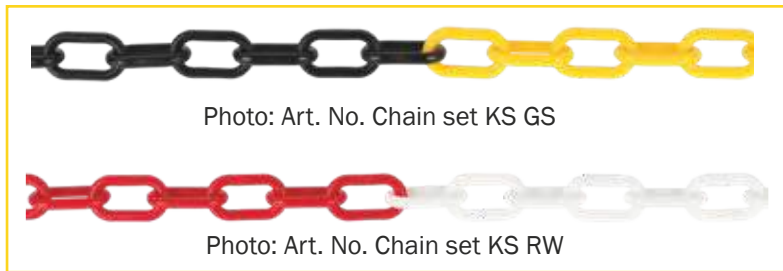

Barrier post with eyelets, height 1.000 mm, Ø 60 mm, steel, galvanized and powder coated, white post with red reflecting foil, TÜV-certified

Art. No.	Color	Weight
10-10-1	yellow-black	3,5 kg
10-20-1	red-white with red reflective tape	3,5 kg
Accessories		
MPF	Plaque de base octogonale, pour poteaux Ø 60 mm, 380 mm, 100 % matériau recyclé	7,0 kg
10-00	Impact ground sleeve, for Ø 60 mm posts, galvanized	4,5 kg
20-00-1	Ground sleeve, for Ø 60 mm posts, galvanized	2,7 kg
20-00-2	Ground sleeve, for 74 x 74 mm posts, galvanized	3,0 kg
Kettenset KS GS	Chain set, yellow-black, 6 mm, 25 m	1,5 kg
Kettenset KS RW	Chain set, red-white, 6 mm, 25 m	1,5 kg
30-00	Slider plate for posts with a 120 x 195 mm base plate	2,1 kg





aus Stahl

SINGLE BARRIER POSTS FOR CONCRETE SETTING



other RAL colors available



Customized versions possible!



Photo: Delivery incl. mounting iron

TÜV-certified for you!

(compliant with DGUV 108-007 / previously BGR 234)



Photo: Art. No. 20-10+OESEN

Photo: Art. No. 20-20+OESEN

Photo: Art. No. 20-30+OESEN

Photo: Art. No. 20-40+OESEN

Photo: Art. No. 20-10

Photo: Art. No. 20-20

Photo: Art. No. 20-30

Photo: Art. No. 20-40

Art. No.	Description	Weight
Barrier post to set in concrete with eyelets, steel, galvanized and powder coated, height 1.400 mm, red-white post with red reflecting foil, mounting rod included, TÜV-certified		
20-10+OESEN	Barrier post red-white round, Ø 60 mm, with eyelets	5,7 kg
20-20+OESEN	Barrier post yellow-black round, Ø 60 mm, with eyelets	5,7 kg
20-30+OESEN	Barrier post red-white square, 70 x 70 mm, with eyelets	6,2 kg
20-40+OESEN	Barrier post yellow-black square, 70 x 70 mm, with eyelets	6,2 kg
Barrier post to set in concrete, steel, galvanized and powder coated, height 1.400 mm, red-white post with red reflecting foil, mounting rod included, TÜV-certified		
20-10	Barrier post red-white round, Ø 60 mm	5,5 kg
20-20	Barrier post yellow-black round, Ø 60 mm	5,5 kg
20-30	Barrier post red-white square, 70 x 70 mm	6,1 kg
20-40	Barrier post yellow-black square, 70 x 70 mm	6,1 kg



<https://nagoya.hu/>
Any questions? Please call us
+36 24/526-026



other RAL
colors
available



Steel

CHAIN POST SET

The chain post set consists of six posts, mobile base plates (7 kg) and a polyethylene chain with a total length of 25 m. The chain post set is available in red-white with red reflecting foil and in yellow-black.



Art. No.	Description	Weight
KPS-GS	Chain post set yellow-black	72,5 kg
KPS-RW	Chain post set red-white with red reflecting foil	72,5 kg

Use outdoors and indoors

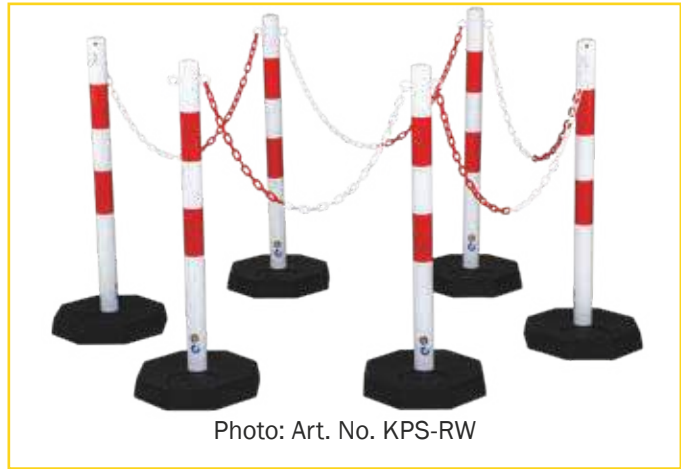
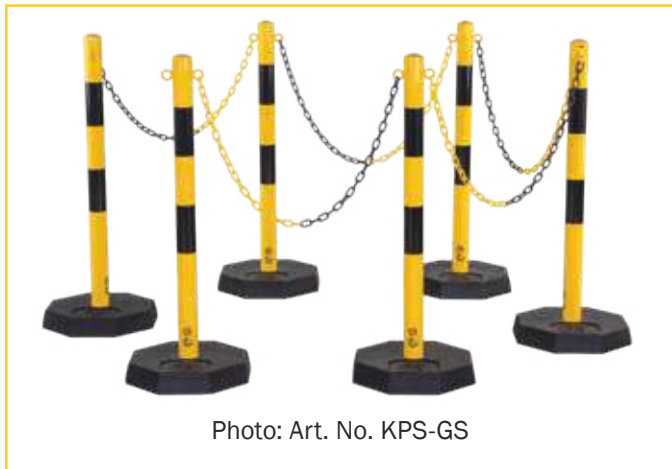

Steel posts: TÜV-certified for you!
(compliant with DGUV 108-007 / previously BGR 234)



<https://nagoya.hu/>
Get more information by email
nagoya@nagoya.hu





Steel

TRANSPORT RACK WITH CHAIN POST SET

The transport rack for the chain post set is the best solution to move and store the individual components. Easy handling and transport of the items are granted by casters.



other RAL
colors
available



Art. No.	Description	Weight
KPS-TG-2-GS	Transport rack and chain post set yellow-black: transport rack, 6 galvanized and powder coated posts with eyelets (Ø 60 mm, height 1.000mm), 6 octagonal base plates 7 kg, 25 m polyethylene chain	92,0 kg
KPS-TG-2-RW	Transport rack and chain post set red-white: transport rack, 6 galvanized and powder coated posts with eyelets (Ø 60 mm, height 1.000mm), 6 octagonal base plates 7 kg, 25 m polyethylene chain	92,0 kg
KPS-BAG	Protective storage case for transport rack with chain post set, made of hard-wearing polyester fabric for in- and outdoor use, water-resistant and UV-stable, fastening cord in hemline, black	0,4 kg

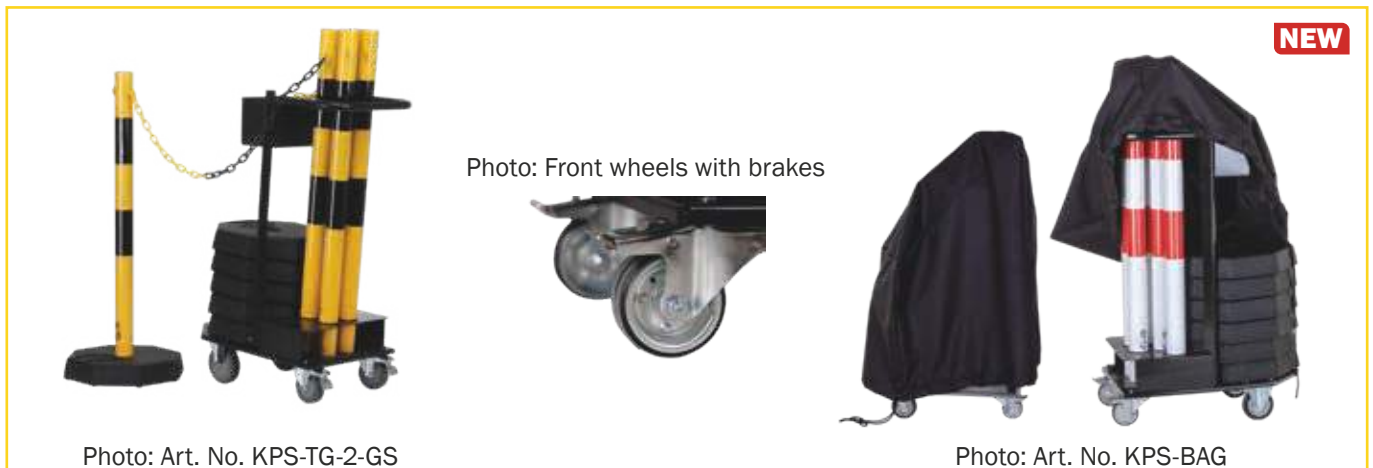

Photo: Front wheels with brakes

Photo: Art. No. KPS-TG-2-GS

Photo: Art. No. KPS-BAG

Steel posts: TÜV-certified for you!

(compliant with DGUV 108-007 / previously BGR 234)



Photo: Art. No. KPS-TG-2-RW



<https://nagoya.hu/>
Any questions? Please call us
+36 24/526-026



Polyethylene

LIGHT CHAIN POST SET

The light chain post set consists of 6 posts (Ø 40 mm) with eyelets, 6 mobile base plates and a polyethylene chain with a total length of 10 m. Suitable for indoor use. The set of chain posts is available in yellow-black and red-white.

For indoor use.

Chain post set, polyethylene, 6 posts, height 860 mm, Ø 40 mm, 6 black base plates, 10 m chain, including connectors



Art. No.	Description	Weight
SET-LKP-GS	Chain post set yellow-black	11,4 kg
SET-LKP-RW	Chain post set red-white	11,4 kg

Polyethylene

FLEXIBLE POSTS

The flexible posts are used for traffic separation and routing and for highlighting dangerous areas. Due to the fully reflective foil, the barrier post is highly perceptible and can easily be run over in an emergency without taking any damage. Afterwards, it rises on its own. Due to the bayonet lock, the product can be removed quickly.

Flexible post, polyethylene, Ø 100 mm, tilting mechanism 360°, auto-erecting, red-white reflecting RA 2 foil, rubber foot Ø 275 x 70 mm, floor mounting via 4 drill holes Ø 10 mm

Art. No.	Height	Rubber foot	Weight
SB450	450 mm	Ø 275 x 50 mm	1,1 kg
SB750	750 mm	Ø 275 x 50 mm	2,0 kg
SB1000	1000 mm	Ø 275 x 50 mm	2,5 kg
SB-FIX	Fixing material		





Polyurethane

FLEXIBLE POSTS

The flexible posts made of polyurethane are an inexpensive entry-level version for the delimitation and marking of areas. The properties of the product make so that during a collision it deforms and then returns into its original shape. The tilting effect is possible at a 360° radius. The different versions in coloring and height allow for a wide scope of application. The reflecting stripes increase safety. The posts are produced in one piece and can be bolted to the floor via 3 drill holes. Caps for a chain set are available separately.

Flexible post, tiltable at 360°, Ø 80 mm, auto-erecting, posts with reflective warning stripes

Height	Color Orange Art. No.	Color Black Art. No.	Weight
450 mm	FP450	-	0,9 kg
750 mm	FP750	FP750 S	1,3 kg
1000 mm	FP1000	FP1000 S	1,6 kg
Fixing material 3 pieces/set			



FLEXIBLE POST SET WITH CHAIN

6 flexible posts, tiltable at 360°, Ø 80 mm, auto-erecting, black with reflective warning stripes, 10 m chain set yellow-black, 6 caps

Art. No.	Height	Diameter	Weight
SET-FP-GS-750	750 mm	80 mm	8,0 kg
SET-FP-GS-1000	1000 mm	80 mm	10,0 kg



<https://nagoya.hu/>
Any questions? Please call us
+36 24/526-026



Rubber

PARK STOP

The parking stop is a quick and uncomplicated way to not only visibly delimit parking spaces. The stop function prevents damage not only to the vehicle but also to buildings, walls or other obstacles. The parking stop can be used indoors and outdoors individually and over the long term. The parking stop can also be used on building walls as impact

protection.

The 100% recycled rubber is UV-stable and will not be affected even in the cold season. It is mounted with screws via the additionally reinforced pre-drilled holes in the product. For optimal visibility and durability, the parking stop is equipped with yellow reflective warning markings.



Art. No.	Description	Length	Width	Height	Weight
PS 90	Park stop 90 cm	870 mm	152 mm	102 mm	8,0 kg
PS 180	Park stop 180 cm	1820 mm	152 mm	102 mm	17,0 kg
PS 90 FIX	Fixing material for Art. No. PS90				
PS 180 FIX	Fixing material for Art. No. PS180				

Rubber

HEAVY-DUTY WHEEL STOP

The heavy-duty version of the parking stop is a massive parking space barrier and manoeuvring aid designed for long-term use. It is primarily used for trucks, buses, industrial trucks and large vehicles. The truck wheel stop prevents damage to vehicles, buildings and machines,

buildings and machines.

This heavy duty truck wheel stop is made from high density, 100% recycled rubber. For optimal visibility and durability, the parking stop is equipped with yellow reflective warning markings. In addition, a cable up to a diameter of 20mm can be passed under the truck

wheel stop.

Mounting is done with screws via the additionally reinforced pre-drilled holes in the product.

Art. No.	Description	Length	Width	Height	Weight
HDWS 100	Heavy-duty wheel stop	1000 mm	300 mm	150 mm	25 kg
FS-FIX	Fixing material				



Rubber

CURB RAMP

The curb ramps allow for barrier-free access to sidewalks. Whether garage entrances or industrial areas - motor vehicles, bicycles, wheelchairs, or forklifts find solid grip on its profiled surface. The curb ramp can also be bolted to the ground for permanent use. The channels at the bottom of the ramp can serve as water drainage or cable tunnels. The material is resistant to environmental influences and allow for long-term use.

Art. No.	Description	Width	Height	Weight
BSR100	Ramp	600 mm	100 mm	11,0 kg
BSR150	Ramp	600 mm	150 mm	20,0 kg





PVC / Rubber mix

HOSE AND CABLE PROTECTOR

The hose and cable bridges are a quick-to-use protection for hoses and cables in traffic areas. The 3 inlets on the bottom allow the insertion of cables and hoses of up to \varnothing 40 mm. The grooved bottom side prevents shifting to enable fast crossing. The hose and cable bridges are completely imbued to ensure long-term use. The variants are available in different lengths to serve all areas.



For hoses and cables, with 3 inlets: 2 x \varnothing 20 mm and 1 x \varnothing 40 mm. Weight capacity: 40 t. Easily installed by one person.

Art. No.	Description	Material	Length	Width	Height	Weight
20012	Cable bridge yellow	PVC / rubber mix	1200 mm	210 mm	65 mm	12,5 kg
20014	Cable bridge black	PVC / rubber mix	1200 mm	210 mm	65 mm	12,5 kg
20010	Cable bridge yellow	PVC / rubber mix	1500 mm	210 mm	65 mm	13,2 kg

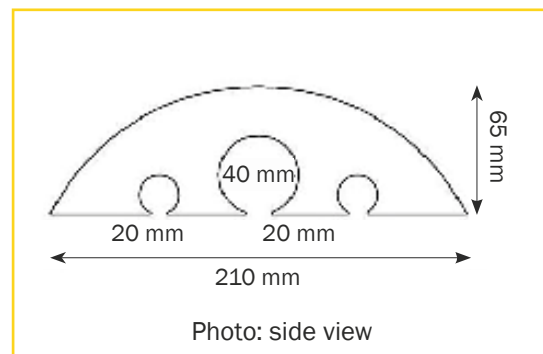

Photo: Art. No. 20010 or 20012





Rubber

HOSE AND CABLE PROTECTORS

These hose and cable bridges are the best possible protection for hoses and cables for both in- and outdoors. They are colored all the way through. If necessary, the individual parts can be connected. The resilience allows the passage of trucks of up to 40 t and ensures functionality even in bad weather conditions. Depending on the requirements posed by the crossing vehicles, wide or narrow versions can be offered. When combined, the yellow and black protectors give the impression of a speed ramp and further increase safety.



Trouble-free passing for trucks with a total weight of 40t



For hoses and cables with 2 inlets \varnothing 75mm, height 90 mm, with reflective foil, arbitrarily expandable. Weight capacity: 40 t. Easily installed by one person.

Art. Nro	Width	Length	Color	Weight
20020	300 mm	830 mm	black	14,6 kg
20070	680 mm	830 mm	black	29,0 kg
20025	300 mm	830 mm	yellow	14,6 kg
20075	680 mm	830 mm	yellow	29,0 kg

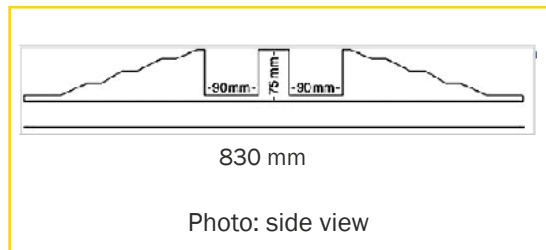

Solid Color quality

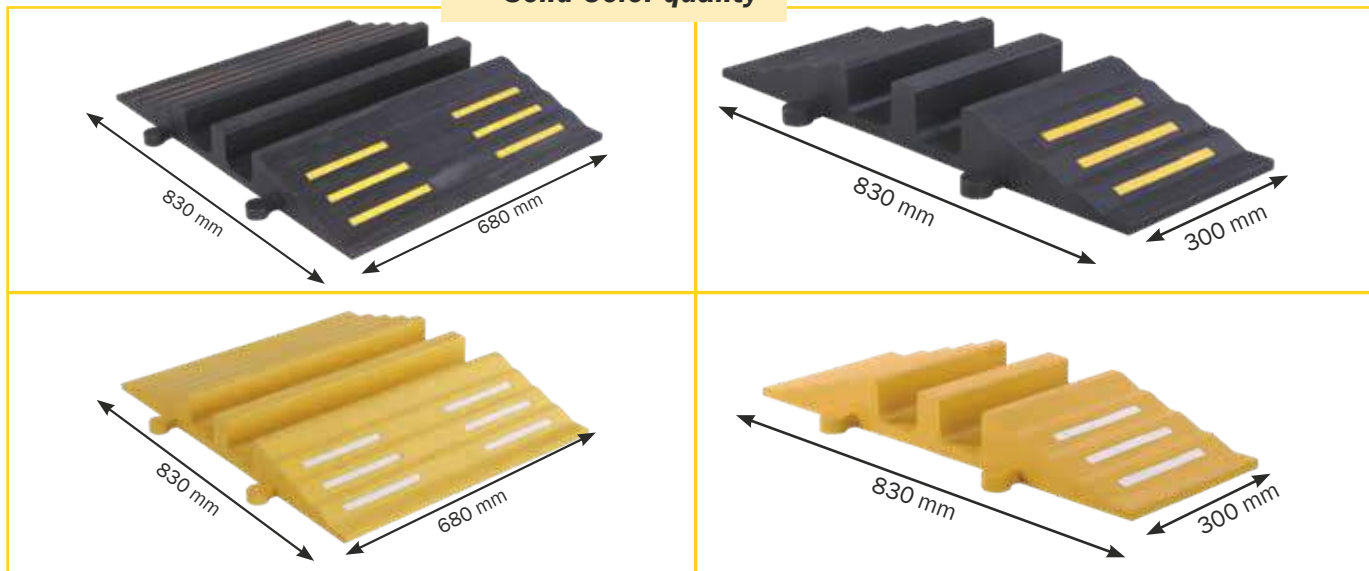



Rubber with PE-lid

CABLE BRIDGE WITH LID

The modular cable bridges with lid are a reliable protection in streets or pathways. The yellow-black coloring allows fast recognition. The individual elements can be connected via connectors on either side. Cables are easily inserted from above. The lid is made of a highly resistant plastic. The chamfered sides allow for a smooth passage and trouble-free traffic flow. The axle load for the article 200D2K is 5t, for articles 200D3K and 200D5K it is 9t, to be passed at walking pace. The recommended crossing speed is 5-10kmh.



Cable bridge with yellow, heavy duty lid made of PE, with handle, arbitrarily expandable via connectors, body made of black recycling rubber, with 4 drill holes, heavy load traffic possible.

Art. No.	Number of tunnels	Length	Width	Height	Weight
200D2K	2 tunnels each 32 x 30 mm	980 mm	240 mm	45 mm	6,5 kg
200D3K	3 tunnels 50 mm x 68 / 57 / 65 mm	900 mm	500 mm	70 mm	16,5 kg
200D5K	5 tunnels each 35,3 x 38 mm	900 mm	500 mm	50 mm	17,0 kg
200D3K45R	3 tunnels 45° angle right		500 mm	70 mm	7,5 kg
200D3K45L	3 tunnels 45° angle left		500 mm	70 mm	7,5 kg
200D5K45R	5 tunnels 45° angle right		500 mm	50 mm	6,0 kg
200D5K45L	5 tunnels 45° angle left		500 mm	50 mm	6,0 kg



Photo: Art. No. 200D2K



Photo: Art. No. 200D3K



Photo: Art. N. 200D5K



Photo: Art. No. 200D3k45L



<https://nagoya.hu/>
Any questions? Please call us
+36 24/526-026



New rubber

SPEED RAMPS

Made from up to 70% recycled rubber. Increased visibility due to yellow-black warning marking. High signalling effect due to integrated reflectors. Quick and easy to use.

Height: 50 mm or 75 mm.

Recommended max. speed:

Height 50 mm: max. 20 km/h

Height 75 mm: max. 10 km/h

Fixing material separately available.



**Trouble-free passing
for trucks with a total
weight of 40t**

Height 50 mm Art. No.	Description	Weight	Height 75 mm Art. No.	Description	Weight
45010	Middlepiece yellow, 510 x 400 mm	7,8 kg	47510	Middlepiece yellow, 510 x 400 mm	11,29 kg
45011	Middlepiece black 510 x 400 mm	7,8 kg	47511	Middlepiece black, 510 x 400 mm	11,29 kg
45020	Start piece (male), yellow, 202 x 400 mm	2,15 kg	47520	Start piece (male), yellow,, 211 x 400 mm	3,17 kg
45021	Start piece (male), black, 202 x 400 mm	2,15 kg	47521	Start piece (male), black, 211 x 400 mm	3,17 kg
45030	End piece (female), yellow 202 x 400 mm	2,17 kg	47530	End piece (female), yellow, 205 x 400 mm	3,08 kg
45031	End piece (female), black, 202 x 400 mm	2,17 kg	47531	End piece (female), black, 205 x 400 mm	3,08 kg
Fixing material for start and end piece Art. No. FS-FIX3					
Fixing material for middle piece Art. No. FS-FIX 4					



Photo: Art. No. 47521 and 47531



Photo: Art. No. 45020 and 45030



Photo: Art. No. 45010



Photo: sample setup

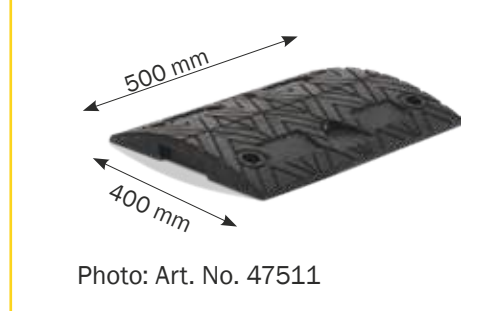

Photo: Art. No. 47511





Polyethylene

BARRIER FENCE

The barrier fences are the perfect solution for blocking off and marking obstacles. The big and solid feet in combination with the hook-and-eye element ensure high stability.

For storage and transportation, the feet can be rotated.

White and yellow type: with red-white reflective foil RA 1

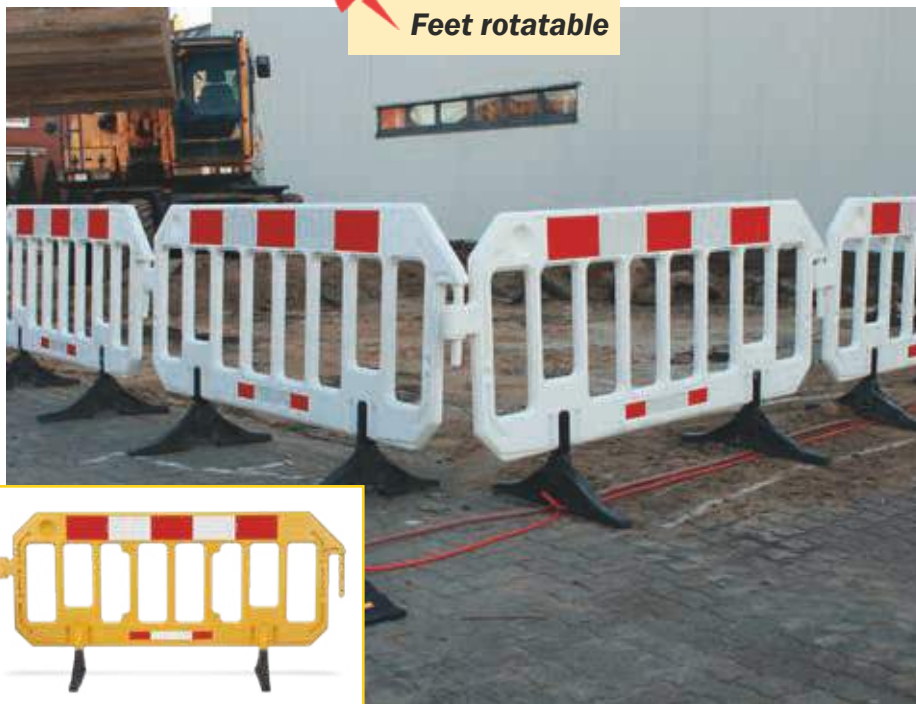

Feet rotatable



Art. No.	Description	Size	Weight
20001	Barrier fence white, foil RA1	2000 x 1000 x 50 mm	15,2 kg
20002	Barrier fence yellow, foil RA1	2000 x 1000 x 50 mm	15,2 kg

STORAGE AND TRANSPORT RACK

Art. No.	Description	Size	Weight
Storage and transport rack, galvanized, stackable, lifting possible by forklift or crane, for use on crane, the base frame is equipped with a spring ring			
LTG-AG	Storage and transport rack, galv.	1700 x 820 x 1250 mm	47,2 kg
VE-LTG-20001	Complete set: storage and transport rack incl. 15 pieces white barrier fences (art. no. 200001)	2000 x 820 x 1250 mm	275,5 kg
VE-LTG-20002	Complete set: storage and transport rack incl. 15 pieces yellow barrier fences (art. no. 200002)	2000 x 820 x 1250 mm	275,5 kg

Product video



Scan me



max. 15 barriers



<https://nagoya.hu/>
Any questions? Please call us
+36 24/526-026



Polyethylene

QUICK BARRIER FENCE

The two-piece or three-piece barrier fence is a fast and cost-effective solution to shut off dangerous areas.

The red and white reflective warning marking ensures increased visibility during use. The individual elements are modularly expandable by means of clip connectors. The low weight and foldable modules allow for easy storage and transport.

Barrier fence, polyethylene, modular units connectable via clips, space saving storage, yellow, red-white reflective foil RA 1, individual unit measurements 800 mm x 970 mm x 30 mm, total width 2.000 mm or 3.000 mm



Photo: Art. No. 20005, 2 parts

Art. No.	Description	Width	Height	Thickness	Weight
20005	Barrier fence, 2 parts	2000 mm	800 mm	30 mm	6,0 kg
20006	Barrier fence, 3 parts	3000 mm	800 mm	30 mm	9,0 kg



Photo: Art. No. 20006, 3 parts





Steel

FLOOR MARKER FOR TAPE ROLLS 50-75 MM

The floor marker helps place markings for internal pathways according to workplace regulations.

The floor marker is suitable for tape rolls of 50-75 mm and enables an easy and precise application on dry, fat- and dust-free surfaces.



Ground marking device and tape

Art. No.	Description	Weight
BMG	Floor marker for tape rolls 50-75 mm	9,9 kg
Ground marking tape for floor marker, PVC, 5 pieces per set, water resistant, with non-corrosive and resistant glue		
SET-MB-G-50	5 rolls ground marking tape, yellow, width 50 mm, material thickness 0,16 mm, length 33 m	1,8 kg
SET-MB-G-75	5 rolls ground marking tape, yellow, width 75 mm, material thickness 0,16 mm, length 33 m	2,8 kg
SET-MB-GS-50	5 rolls ground marking tape, yellow, width 75 mm, material thickness 0,16 mm, length 33 m	2,5 kg
SET-MB-GS-75	5 rolls ground marking tape, yellow-black, width 50 mm, material thickness 0,2 mm, length 33 m	3,9 kg
Ground marking tape, made of metal, can be driven over, material thickness 0,7 mm, width 100 mm		
MB-ST1	100 mm x 1,5 m length, 1 piece	0,2 kg
MB-ST2	100 mm x 6,0 m length, 1 piece	1,4 kg



Photos: Art. No. BMG



Photo: Art. Nr. SET-MB-GS-75



<https://nagoya.hu/>
Any questions? Please call us
+36 24/526-026

5 Customized versions possible!



Steel

RAMP GUARDRAILS

The galvanized crash stop ramp protection guard allows you to secure ramps in industrial areas where fast access is needed. The design ensures quick removal from and insertion to the mounting sleeves. The modular system can be expanded as required via start/end sleeves and middle sleeves. Meanwhile, the flat design of the mounting sleeves ensures problem-free handling of pallets and goods.



Ramp guardrail, galvanized, Ø 60 mm, mounting sleeves with drill holes Ø 12,5 mm

Art. No.	Description	Height	Width	Length	Weight
RSG-1000	Ramp guardrail with cross bar, galvanized	1300 mm	1000 mm		14,6 kg
RSG-MH	Mounting sleeve with two receptacles, galvanized	200 mm	125 mm	200 mm	7,5 kg
RSG-AEH	Mounting sleeve start/end piece, galvanized	200 mm	125 mm	130 mm	3,1 kg



Photo: Art. No. RSG-1000



Photo: Art. No. RSG-MH



Photo: Art. No. RSG-AEH

<https://nagoya.hu/>
Get more information by email
nagoya@nagoya.hu





TÜV-certified for you!
 (compliant with DGUV 108-007 / previously BGR 234)



Customized versions possible!



Steel

MODULAR TRUCK POSITIONING AID

The 3.000 mm long truck positioning aids, optimally designed for transport and mounting, are the perfect addition for loading ramps.

The modular truck positioning aid in yellow-black or red-white enables a safe and easy docking process and further protects buildings and dock shelters.

The floor anchors for the massive construction with a Ø 159 mm are available separately (Art.-nr. LKW-EFH-FIX).

To facilitate the docking process, the truck positioning aid is opened at an 15° angle in the front section.

Modular truck positioning aid, set of 2 units right and left, steel, galvanized and powder coated for outdoor use, Ø 159 mm, length 3.000 mm, 15° angle, delivery in two pieces.



Photo: Art. No. LKW-EFH-A GS

Art. No.	Description	Weight
Floor mounting, with 3 base plates 300 mm x 300 mm 6 drill holes Ø 18 mm, 15° angle, height 315 mm		
LKW-EFH-A GS	yellow-black	150,0 kg
LKW-EFH-A RW	red-white	150,0 kg
LKW-EFH-FIX	Set composite anchor cartridges	



Photo: Art. No. LKW-EFH-A RW
 2 pieces per side



<https://nagoya.hu/>
 Any questions? Please call us
 +36 24/526-026



TÜV-certified for you!
(compliant with DGUV 108-007 / previously BGR 234)



Steel TRAILER STAND

Our TÜV-certified (compliant with DGUV 108-007 / previously BGR 234) trailer stand helps increase safety during loading and unloading of trailers up to 40 tons.

Tipping of semi-trailers is effectively avoided by using our trailer-stand.

According to DGUV 208-006 and DGUV 208-009, professional associations strongly recommend the use of additional protection during loading processes.



- Extra large trailer contact pad 760 x 120 mm
- Solid tires
- Easy handling
- Large base plate 470 x 425 mm

Art. No.	Description	Farbe	Height	Weight
DVS1	Trailer stand	yellow	1025 - 1344 mm	86,0 kg



Product video



Scan me!



TRAFFIC MIRRORS



TM traffic mirrors



Ice-free traffic mirrors



TM traffic mirrors



TM-I traffic mirrors



4-point ball-joint mounting bracket



TM-I traffic mirrors



Multi-use mirrors



2-point universal bracket



Mirror Explorer 180°



Mirror Subway



Mirror Panorama 180°



Mirror Trixi



Traffic Mirrors
FIXINGS

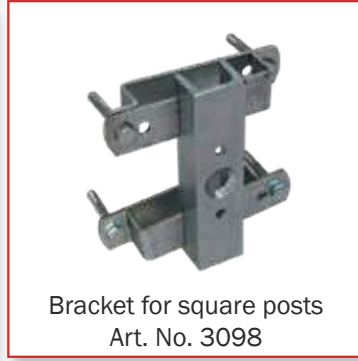

MATERIAL OVERVIEW

	Acrylic	Polycarbonate	Inox
Material	70 % more impact resistant than glass	Nearly indestructible	Nearly indestructible
	UV-stable	UV-stable	UV-stable
	Low weight	Low weight	High temperature resistance
	Impact resistant according to DIN EN ISO 179-1	Low flammability	Chemical resistance

<https://nagoya.hu/>
 Get more information by email
nagoya@nagoya.hu



TRAFFIC MIRRORS

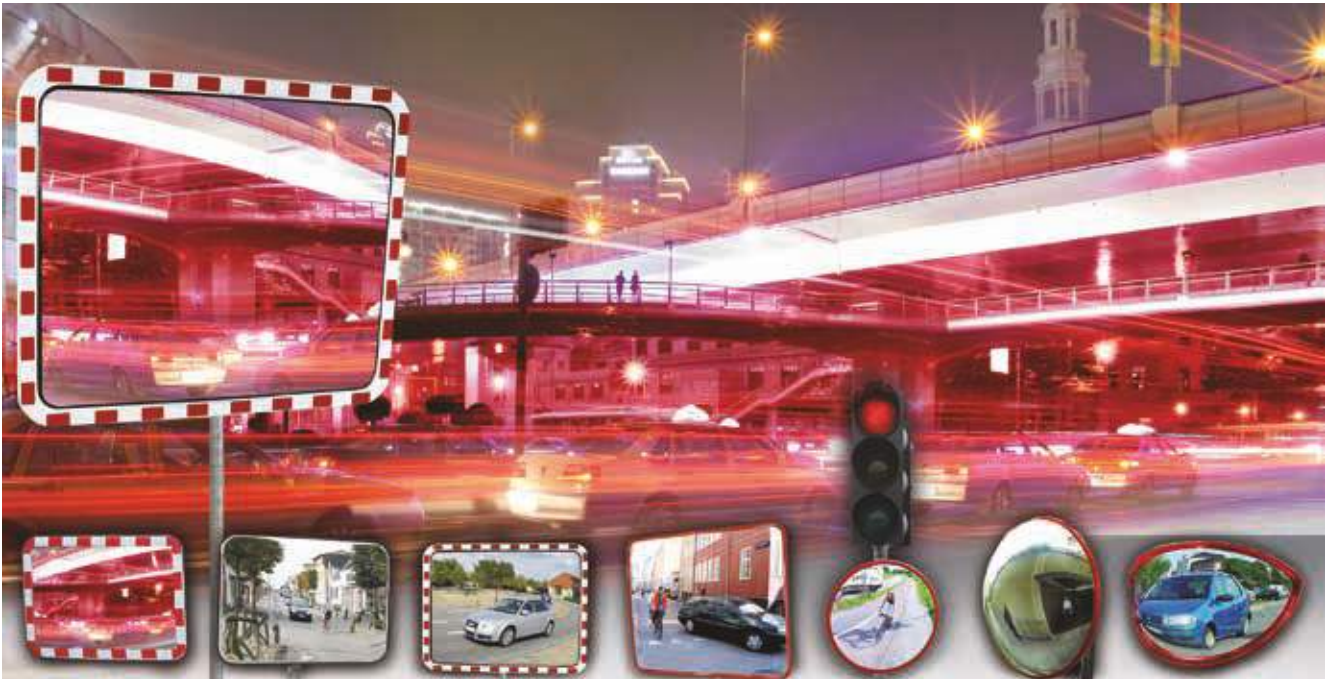

The TÜV-certified DANCOP mirrors are characterized by very solid and durable construction. All DANCOP mirrors have a metallized backside, which enables a very clear and brilliant image and a high resistance against environmental influences.

All DANCOP traffic mirrors are UV-stable and equipped with robust fixing brackets that are always included in the delivery. Our standard-material acrylic is 70 % more shock-resistant than glass.

The advantages of DANCOP-mirrors:

- UV-stable
- Brilliant mirror image without distortion
- Easy installation

Finding the correct mirror

1. Application	Indoor use Outdoor use
2. Material	Acrylic: 70 % more shock-resistant than glass Polycarbonate: nearly indestructible INOX: temperature resistance and chemical resistance
3. Size / fixing	The bigger the mirror, the better the visibility and representation

For items as per description:

- Most massive fixing on the market: 4-point ball joint mounting bracket
- Fixing for round or rectangle post or wall fixing included
- Wind load-tested until wind force 12 (hurricane > 117 km/h)

Product video



Scan me!



Our mirrors are TÜV certified



Wind load certified up to force 12



<https://nagoya.hu/>
Any questions? Please call us
+36 24/526-026

Traffic Mirrors

TM TRAFFIC MIRROR



Video mirror mount
4-point ball joint mount

Traffic mirror video



Application
Outdoor and indoor

Material
Acrylic or Polycarbonate or Inox

Fixing
Post or wall

Warranty
5 years

Our TM-mirror is equipped with a white frame with red reflecting RA2 foil for a better visibility on the streets.



Photo: round design



Photo: Back side: 4-point fixing with ball joint for an optimal fixation. Included in scope of delivery.

Art. No.	Description	Weight	Viewing distance
TM AC 60	Acrylic, round ø 60 cm	5,2 kg	9 - 15 m
TM AC 80	Acrylic, round ø 80 cm	7,6 kg	15 - 22 m
TM AC 40 X 60	Acrylic 40 x 60 cm	5,0 kg	9 - 15 m
TM AC 60 X 80	Acrylic 60 x 80 cm	8,8 kg	15 - 22 m
TM AC 80 X 100	Acrylic 80 x 100 cm	12,0 kg	22 - 27 m
TM AC 100 X 120	Acrylic 100 x 120 cm	15,0 kg	27 - 32 m
TM PC 60	Polycarbonate, round ø 60 cm	5,1 kg	9 - 15 m
TM PC 80	Polycarbonate, round ø 80 cm	7,5 kg	15 - 22 m
TM PC 40 X 60	Polycarbonate, 40 x 60 cm	5,2 kg	9 - 15 m
TM PC 60 X 80	Polycarbonate, 60 x 80 cm	6,3 kg	15 - 22 m
TM PC 80 X 100	Polycarbonate, 80 x 100 cm	12,5 kg	22 - 27 m
TM INOX 60	Inox, round ø 60 cm	8,3 kg	9 - 15 m
TM INOX 80	Inox, round 80 cm	10,0 kg	15 - 22 m
TM INOX 40 X 60	Inox, 40 x 60 cm	10,0 kg	9 - 15 m
TM INOX 60 X 80	Inox, 60 x 80 cm	12,1 kg	15 - 22 m

<https://nagoya.hu/>
Get more information by email
nagoya@nagoya.hu



Traffic Mirrors

TM-B INOX

ICE-FREE TRAFFIC MIRROR



Video of the fixing of the mirror 4-point fixing



Traffic mirror video



Application
Outdoor and indoor

Material
Inox

Fixing
Post or wall

Warranty
5 years

The combination of the INOX mirror surface and the built-in special cushions in the back prevent ice formation on the mirror surface.

Please be aware that our ice-free mirror can fog-up in cases of fast arising and freezing fog, or in exceptionally cold periods without temperature fluctuations.



Photo: round type



Photo: Back side: 4-point fixing with ball joint for an optimal fixation. Included in scope of delivery.

Art. No.	Description	Weight	Viewing distance
TM-B INOX 60	Inox, round ø 60 cm	12,2 kg	9 - 15 m
TM-B INOX 80	Inox, round 80 cm	14,8 kg	15 - 22 m
TM-B INOX 40 X 60	Inox, 40 x 60 cm	10,1 kg	9 - 15 m
TM-B INOX 60 X 80	Inox, 60 x 80 cm	17,3 kg	15 - 22 m



<https://nagoya.hu/>
Any questions? Please call us
+36 24/526-026

Traffic Mirrors

TM-I TRAFFIC MIRROR

Including 4-point ball joint mounting bracket for precise installation



Video mirror mount
4-point ball joint mount



Application
Outdoor and indoor

Material
Acrylic or Polycarbonate

Fixing
Post or wall

Warranty
5 years

Our TM-I mirror increases the safety in private and industrial areas. Parking lots, private driveways, shopping centers, and railway platforms are popular operation sites as well. The red frame further enhances the visibility.



Photo: round design



Photo: Back side: 4-point fixing with ball joint for an optimal fixation.
Included in scope of delivery.

Art. No.	Description	Weight	Viewing distance
TM-I AC 50	Acrylic, round ø 50 cm	4,2 kg	5 - 7 m
TM-I AC 60	Acrylic, round ø 60 cm	6,0 kg	9 - 15 m
TM-I AC 80	Acrylic, round ø 80 cm	6,4 kg	15 - 22 m
TM-I AC 40 X 60	Acrylic, 40 x 60 cm	4,4 kg	9 - 15 m
TM-I AC 60 X 80	Acrylic 60 x 80 cm	6,4 kg	15 - 22 m



Traffic Mirrors

MULTI-USE MIRROR UNI-SIG

with or without retro-reflecting marking tape



Video mirror assembly
Universal mirror



Application
Outdoor and indoor

Material
Acrylic

Fixing
Post or wall

Warranty
2 years

The UNI-SIG mirror is an economic alternative, used in areas with limited sight: in parking lots, garage exits, and shopping centers.

Art. No.	Description	Weight	Viewing distance
With reflecting frame			
US TYP1 4060	Acrylic, 40 x 60 cm	4,3 kg	5 - 7 m
US TYP1 6080	Acrylic, 60 x 80 cm	5,9 kg	9 - 15 m
US TYP1 80100	Acrylic, 80 x 100 cm	9,0 kg	15 - 22 m



Photo: Backside with 2-point universal bracket. Horizontal or vertical use possible. Included in scope of delivery.



Photo: Variant with reflective tape
Art. No. US Typ1 60 X 80



<https://nagoya.hu/>
Any questions? Please call us
+36 24/526-026

Traffic Mirrors

EXPLORER

180° view



Video mirror assembly
Universal mirror



Application
Outdoor and indoor

Material
Acrylic

Fixing
Post or wall

Warranty
2 years

The Explorer wide angle mirror with its convexity of 180° ensures an optimum field of vision. It is ideal to get an overview of production areas or traffic.



Photo: Rear side 2-point universal mount. Horizontal and vertical locking possible. *Included in scope of delivery.*

Art. No.	Description	Weight	Viewing distance
EXPLORER 60	Acrylic, round ø 60 cm	5,2 kg	9 - 15 m
EXPLORER 80	Acrylic, round ø 80 cm	7,0 kg	15 - 20 m

Traffic Mirrors

MIRROR PANORAMA 180°

180° view

Made of nearly indestructible polycarbonate 6 mm

PANORAMA

SUBWAY



Application
Outdoor and indoor

Material
Polycarbonate

Fixing
Post or wall

Warranty
5 years

Both mirrors have an especially wide angle of 180° which provides an enlarged view.

The two 180° versions vary in construction. The SUBWAY-mirror can be mounted not only on posts but directly on the wall as well, by means of the fixing ring. This way it can be seamlessly integrated in underground stations, underpasses and parking garages, making dark corners safer.

The PANORAMA-mirror additionally disposes of a white frame with green reflectors for better visibility during night-time or bad weather conditions.

Material: The nearly indestructible polycarbonate makes these the perfect mirrors for areas with much vandalism.

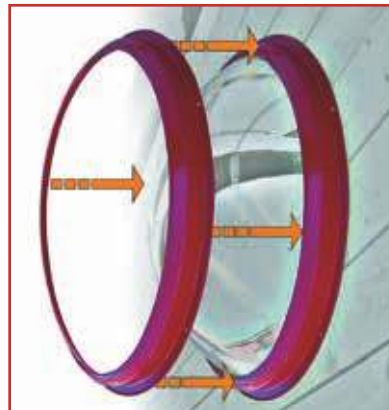

Photo: Art. No.: SUBWAY-R steel ring for wall fixing SUBWAY-mirror



Photo: Backside 4-point ball joint mounting bracket. *Included in scope of delivery.*



Video mirror mount
4-point ball joint mount

Art. No.	Description	Weight	Viewing distance
SUBWAY-W	Polycarbonate, ø 60 cm steel ring for wall fixing	6,0 kg	9 - 15 m
SUBWAY	Polycarbonat, ø 60 cm with 4-point joint mounting bracket	6,0 kg	9 - 15 m
TM PC 360	Polycarbonate, ø 60 cm	9,1 kg	15 - 22 m



<https://nagoya.hu/>
Any questions? Please call us
+36 24/526-026

Traffic Mirrors

TRIXI-MIRROR

no more blind spots



Application
Outdoor and indoor

Material
Acrylic

Fixing
Post or wall

Warranty
2 years

Our wide-angle traffic mirror Trixi helps gain view of blind spots on crossroads where cyclists and pedestrians are in danger of accidents. When turning, drivers see pedestrians or cyclists in the dangerous blind spot where otherwise they would have been overlooked.



Photo: High visibility of the cyclist in the dead angle



Photo: Backside with standard fixing (incl. adaptor). *Included in scope of delivery.*



Against the „dead angle“

Art. No.	Description	Weight	Viewing distance
TRIXI 35	Acrylic, round ø 35 cm	2,0 kg	1 - 4 m
TRIXI 50	Acrylic, round ø 50 cm	2,7 kg	5 - 7 m
TRIXI 50-H	Acrylic, round ø 50 cm, with heating	4,2 kg	5 - 7 m



Photo: Backside with thermostat



TRAFFIC MIRRORS



ED Traffic mirror



Multi-use mirror



The EUvex-mirrors offer a high-quality mirror image at a low entry price. Whether for traffic, industry, or trade: the EUvex safety mirrors are ideally suited to provide a better view of confusing areas. In contrast to the Dancop mirrors, the EUvex mirrors offer less selection and adjustment options and a smaller product range. The EUvex mirrors are neither TÜV-certified nor wind load certified.

Advantages of EUvex mirrors:

- UV-stable
- Fixing bracket for round posts 50-85 mm included in the delivery
- High quality mirror image
- Easy installation



ED traffic mirrors round



Universal mirrors round



Backside with post fixing



Traffic Mirrors

EUvex TRAFFIC MIRRORS



Application
Outdoor and indoor

Material
Acrylic

Fixing
Post

Warranty
2 years

The EUvex traffic mirror increases safety on roads and premises. Due to its robust design it is suitable for long term outdoor use. The type RA2 reflectors ensure good visibility, even in bad weather conditions.

Material:

The EUvex mirror surface is made of PMMA and equipped with red reflectors (Type RA2) on a white frame. It is UV-stable and weather-resistant.



Photo: round type



Photo: Back side with standard post fixing. *Included in scope of delivery.*

Art. No.	Description	Weight	Viewing distance
ED 40 X 60	Acrylic, 40 x 60 cm	3,3 kg	9 - 15 m
ED 60 X 80	Acrylic, 60 x 80 cm	5,1 kg	15 - 22 m
ED 80 X 100	Acrylic, 80 x 100 cm	8,5 kg	22 - 27 m
ED 60	Acrylic, round ø 60 cm	3,7 kg	9 - 15 m
ED 80	Acrylic, round ø 80 cm	5,2 kg	15 - 22 m
ED-Wand-arm	Wall fixing, distance 20 cm	1,9 kg	



Photo: fixing for wall mounting
Art. No. ED-Wandarm. *Sold separately.*



Traffic Mirrors

EUvex UNIVERSAL MIRRORS



Application Outdoor and indoor	Material Acrylic	Fixing Post	Warranty 2 years
--	----------------------------	-----------------------	----------------------------

The EUvex universal mirror is equipped with a white frame and very versatile.

Material

The EUvex universal mirror surface is made of PMMA, UV-stable and weather-resistant.



Photo: round version



Photo: Back with standard fixing to the post. *Included in scope of delivery.*

Art. No.	Description	Weight	Viewing distance
ED-U 40 X 60	Acryl, 40 x 60 cm	1,8 kg	9 - 15 m
ED-U 60 X 80	Acryl, 60 x 80 cm	4,0 kg	15 - 22 m
ED-U 80 X 100	Acryl, 80 x 100 cm	6,6 kg	22 - 27 m
ED-U 60	Acryl, round ø 60 cm	2,0 kg	9 - 15 m
ED-U 80	Acryl, round ø 80 cm	4,2 kg	15 - 22 m
ED-Wandarm	Wall fixing, distance 20 cm	1,9 kg	



Photo: fixing for wall mounting

Art. No. ED-Wandarm. *Sold separately.*

<https://nagoya.hu/>
Any questions? Please call us
+36 24/526-026



INDUSTRIAL MIRRORS



Check Point



Check Mirror



TM Traffic mirror



TM-I traffic mirror



Mirror multi use

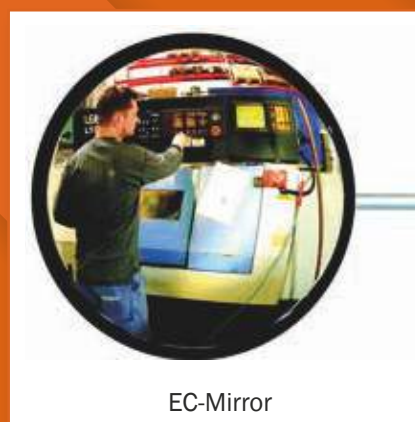

EC-Mirror



INOX HF mirror



Dome mirror 360°



Dome mirror 180°



Transpo 180° mirror

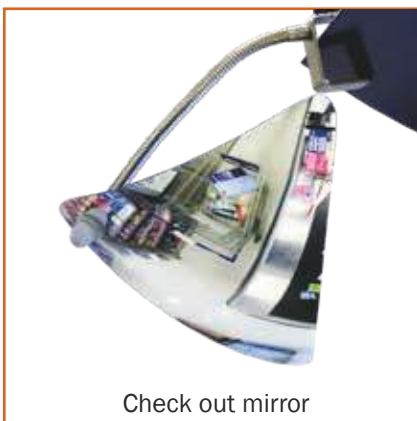

Check out mirror



Inspection mirror

Industrial mirrors
FIXINGS



MATERIAL OVERVIEW

	Acrylic	Polycarbonate	Inox
Material	70 % more impact resistant than glass	Nearly indestructible	Nearly indestructible
	UV-resistant	UV-resistant	UV-resistant
	Light weight	Light weight	High temperature applications possible
	Impact resistant per DIN EN ISO 179-1	Low flammability	Chemical resistant



<https://nagoya.hu/>
Any questions? Please call us
+36 24/526-0276

INDUSTRIAL MIRRORS



The TÜV-certified DANCOP mirrors are characterized by very solid and durable construction. All DANCOP mirrors have a metallized backside, which enables a very clear and brilliant image and a high resistance against environmental influences.

All DANCOP mirrors are UV-stable and equipped with robust fixing brackets that are always included in the delivery. Our standard-material acrylic is 70 % more shock-resistant than glass.

Advantages of DANCOP-mirrors:

- UV-stable
- Brilliant mirror image without distortion
- Easy installation

Finding the correct mirror

1. Application	Indoor use Outdoor use
2. Material	Acrylic: 70 % more shock-resistant than glass Polycarbonate: nearly indestructible INOX: temperature resistant and chemical resistant
3. Size / fixing	The bigger the mirror, the better the visibility and representation

For items as per description:

- Most massive fixing on the market: 4-point ball joint mounting bracket
- Fixing for round or rectangle post or wall fixing included
- Wind load-tested until wind force 12 (hurricane > 117 km/h)

Product video



Scan me!



Our mirrors are TÜV certified



Wind load certified up to force 12

<https://nagoya.hu/>
Get more information by email
nagoya@nagoya.hu



Industrial Mirrors

CHECK POINT

The yellow-black frame increases the visibility.



Video mirror mount
Telescopic mount



Application Outdoor and indoor	Material Acrylic	Fixing Post or wall	Warranty 2 years
--	----------------------------	-------------------------------	----------------------------

Our check point mirror increases attention in hazardous areas of production lines. Distant workstations and blind spots are easily inspected. Workplace accidents and loss of production are effectively reduced.

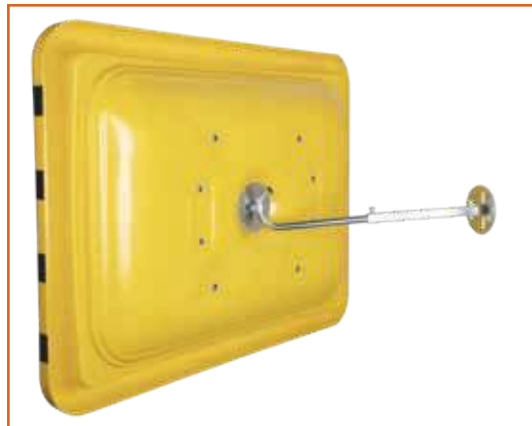

Photo: Telescopic bracket 30 - 50 cm.
Included in scope of delivery.



Photo: Upright position, horizontal-vertical position possible (bracket I or IV).
Sold separately.

Art. No.	Description	Weight	Viewing distance
CP 30 X 50	Acrylic, 30 x 50 cm	1,8 kg	5 - 7 m
CP 40 X 60	Acrylic, 40 x 60 cm	3,0 kg	7 - 12 m
CP 60 X 90	Acrylic, 60 x 90 cm	5,8 kg	12 - 25 m
Alternative brackets for mirrors in sizes 40 x 60 and 60 x 90			
Bracket I	4-point ball joint bracket for wall and post mounting (ø 50 - 85 mm) 2.6 kg		
Bracket IV	Universal bracket for wall and post mounting (ø 50 - 85 mm) 2.4 kg		



Photo above: 4-point ball joint mount
Photo below: 2-point universal mount.
Sold separately. <https://nagoya.hu/>
Any questions? Please call us
+36 24/526-026



Industrial Mirrors

CHECK MIRROR



Application
Indoor

Material
Acrylic

Fixing
Wall

Warranty
2 years

This check mirror has been developed specifically for supervising production lines. The concavity of the mirror enlarges the reflection and control by one person is possible. One-meter distance between product and mirror is recommended.



Photo: Standard bracket Telescopic wall bracket for optimal adjustment.

Included in scope of delivery.

Art. No.	Description	Weight	Viewing distance
CM 30 X 50	Acrylic, 30 x 50 cm	1,0 kg	1 m
CM 40 X 60	Acrylic, 40 x 60 cm	1,4 kg	1 m
CM 60 X 90	Acrylic, 60 X 90 cm	2,6 kg	1 m



Industrial Mirrors

TM TRAFFIC MIRROR



Video mirror mount
4-point ball joint mount



Application Outdoor and indoor	Material Acrylic, Polycarbonate, Inox	Fixing Post or wall	Warranty 5 years
--	---	-------------------------------	----------------------------

Our TM-mirror is equipped with a white frame with red reflecting RA2 foil for a better visibility on the streets.

Art. No.	Description	Weight	Viewing distance
TM AC 60	Acrylic, round ø 60 cm	5,2 kg	9 - 15 m
TM AC 80	Acrylic, round ø 80 cm	7,6 kg	15 - 22 m
TM AC 40 X 60	Acrylic, 40 x 60 cm	5,0 kg	9 - 15 m
TM AC 60 X 80	Acrylic, 60 x 80 cm	8,8 kg	15 - 22 m
TM AC 80 X 100	Acrylic, 80 x 100 cm	12,0 kg	22 - 27 m
TM AC 100 X 120	Acrylic, 100 x 120 cm	15,0 kg	27 - 32 m
TM PC 60	Polycarbonate, round ø 60 cm	5,1 kg	9 - 15 m
TM PC 80	Polycarbonate, round ø 80 cm	7,5 kg	15 - 22 m
TM PC 40 X 60	Polycarbonate, 40 x 60 cm	5,2 kg	9 - 15 m
TM PC 60 X 80	Polycarbonate, 60 x 80 cm	6,3 kg	15 - 22 m
TM PC 80 X 100	Polycarbonate, 80 x 100 cm	12,5 kg	22 - 27 m
TM INOX 60	Inox, round ø 60 cm	8,3 kg	9 - 15 m
TM INOX 80	Inox, round ø 80 cm	10,0 kg	15 - 22 m
TM INOX 40 X 60	Inox, 40 x 60 cm	10,0 kg	9 - 15 m
TM INOX 60 X 80	Inox, 60 x 80 cm	12,1 kg	15 - 22 m



Photo: round design



Photo: Back 4-point ball joint mount for optimal adjustment.
Included in scope of delivery.



<https://nagoya.hu/>
Any questions? Please call us
+36 24/526-026

Industrial Mirrors

TM-B INOX

ICE-FREE TRAFFIC MIRROR



Video mirror mount
4-point ball joint mount



Application Outdoor and indoor	Material Inox	Fixing Post or wall	Warranty 5 years
--	-------------------------	-------------------------------	----------------------------

The combination of the INOX mirror surface and the built-in special cushions in the back prevent ice formation on the mirror surface.

Please be aware that our ice-free mirror can fog-up in cases of fast arising and freezing fog, or in exceptionally cold periods without temperature fluctuations.



Photo: Round design



Photo: Back 4-point ball joint mount for optimal adjustment.
Included in scope of delivery.

Art. No.	Description	Weight	Viewing distance
TM-B INOX 60	INOX, round ø 60 cm	12,2 kg	9 - 15 m
TM-B INOX 80	INOX, round ø 80 cm	14,8 kg	15 - 22 m
TM-B INOX 40 X 60	Inox, 40 x 60 cm	10,1 kg	9 - 15 m
TM-B INOX 60 X 80	Inox, 60 x 80 cm	17,3 kg	15 - 22 m



Industrial Mirrors

TM-I TRAFFIC MIRROR

Including 4-point ball joint mounting bracket for precise installation



Video mirror mount
4-point ball joint mount



Application Outdoor and indoor	Material Acrylic	Fixing Post or wall	Warranty 5 years
--	----------------------------	-------------------------------	----------------------------

The TM-I industrial mirror helps secure hazardous areas. The massive construction ensures long-term use thus justifying the investment.



Photo: round design



Photo: Back 4-point ball joint mount for optimal adjustment.
Included in scope of delivery.

Art. No.	Description	Weight	Viewing distance
TM-I AC 50	Acrylic, round ø 50 cm	4,2 kg	5 - 7 m
TM-I AC 60	Acrylic, round ø 60 cm	6,0 kg	9 - 15 m
TM-I AC 80	Acrylic, round ø 80 cm	6,4 kg	15 - 22 m
TM-I AC 40 X 60	Acrylic, 40 x 60 cm	4,4 kg	9 - 15 m
TM-I AC 60 X 80	Acrylic, 60 x 80 cm	6,4 kg	15 - 22 m



<https://nagoya.hu/>
Any questions? Please call us
+36 24/526-026

Industrial Mirrors

UNI-SIG MULTI-USE MIRROR

with or without reflecting frame



Video mirror assembly
Universal mirror



Application
Outdoor and indoor

Material
Acrylic

Fixing
Post or wall

Warranty
2 years

The UNI-SIG mirror is an economic alternative, used in areas with limited sight: in parking lots, garage exits, and shopping centers.



Photo: example of application



Photo: Rear side 2-point universal mount: horizontal and vertical locking possible! Included in scope of delivery.

Art. No.	Description	Weight	Viewing distance
with retroreflective warning tape			
US Typ1 40 X 60	Acrylic, 40 x 60 cm	4,3 kg	5 - 7 m
US Typ1 60 X 80	Acrylic, 60 x 80 cm	5,6 kg	9 - 15 m
US Typ1 80 X 100	Acrylic, 80 x 100 cm	9,1 kg	15 - 22



Photo: Variant with reflective tape



Industrial Mirrors

SM OBSERVATION MIRROR



Application Outdoor and indoor	Material Acrylic	Fixing Wall	Warranty 2 years
--	----------------------------	-----------------------	----------------------------

The massive construction ensures long-term use both in- and outdoors. The various sizes enable a wide range of application.



Photo: round design



Photo: View of the rear wall shell, standard mount: telescopic wall mount 30 - 50 cm. Included in scope of delivery.

Art. No.	Description	Weight	Viewing distance
SM 35	Acrylic, round ø 35 cm	1,2 kg	1 - 4 m
SM 50	Acrylic, round ø 50 cm	2,0 kg	5 - 7 m
SM 60	Acrylic, round ø 60 cm	2,8 kg	9 - 15 m
SM 80	Acrylic, round ø 80 cm	4,5 kg	15 - 22 m
SM 40 X 60	Acrylic, 40 x 60 cm	2,6 kg	9 - 15 m
SM 60 X 80	Acrylic, 60 x 80 cm	4,4 kg	15 - 22 m



<https://nagoya.hu/>
Any questions? Please call us
+36 24/526-026

Industrial Mirrors

EC OBSERVATION MIRROR



Application
Outdoor and indoor

Material
Acrylic

Fixing
Wall

Warranty
2 years

The most economic type of all our mirrors is especially made for warehouses and production areas. The included telescope bracket ensures perfect positioning.

Art. No.	Description	Weight	Viewing distance
Indoor			
EC-RS 30	Acrylic, round ø 30 cm	0,8 kg	1 - 4 m
EC-RS 40	Acrylic, round ø 40 cm	1,0 kg	1 - 5 m
EC-RS 50	Acrylic, round ø 50 cm	1,2 kg	5 - 7 m
EC-RS 60	Acrylic, round ø 60 cm	1,2 kg	9 - 15 m
EC-RS 70	Acrylic, round ø 70 cm	1,8 kg	12 - 17 m
EC-RS 80	Acrylic, round ø 80 cm	2,2 kg	15 - 22 m
EC-RS 40 X 60	Acrylic, 40 x 60 cm	1,4 kg	1 - 5 m
EC-RS 60 X 80	Acrylic, 60 x 80 cm	2,4 kg	9 - 15 m
Outdoor and indoor			
EC-US 30	Acrylic, round ø 30 cm	1,1 kg	1 - 4 m
EC-US 40	Acrylic, round ø 40 cm	1,4 kg	1 - 5 m
EC-US 50	Acrylic, round ø 50 cm	2,0 kg	5 - 7 m
EC-US 60	Acrylic, round ø 60 cm	2,6 kg	9 - 15 m
EC-US 70	Acrylic, round ø 70 cm	3,4 kg	12 - 17 m
EC-US 80	Acrylic, round ø 80 cm	4,2 kg	15 - 22 m



Photo: rectangular version

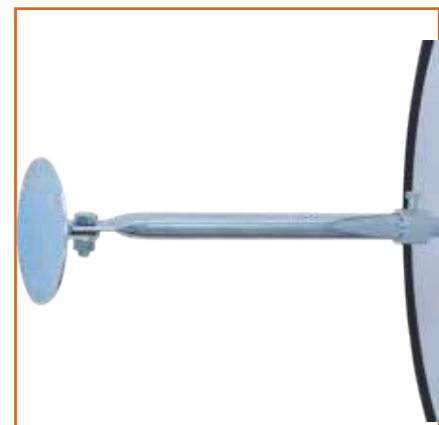

Photo: Standard bracket: Telescopic wall bracket 30 - 50 cm.
Included in scope of delivery.



Industrial Mirrors

INOX INDUSTRIAL MIRROR

Heat resistant up to 350 °C with detachable PVC frame



Application
Outdoor and indoor

Material
Inox

Fixing
Wall

Warranty
2 years

This mirror is made of non-corrosive INOX so it can be used in high temperature areas as well as in the food industry. The PVC frame can be removed after installation.



Photo: rectangular version



Photo: Standard bracket: Telescopic wall bracket 30 - 50 cm.
Included in scope of delivery.

Art. No.	Description	Weight	Viewing distance
INOX HF 45 X 60	Inox, 45 x 60 cm	3,6 kg	9 - 15 m
INOX HF 60	Inox, round ø 60 cm	5,5 kg	9 - 15 m
INOX HF 60 X 80	Inox, 60 x 80 cm	4,7 kg	15 - 22 m
INOX HF 80	Inox, round ø 80 cm	5,8 kg	15 - 22 m



Photo: Removable PVC strond



<https://nagoya.hu/>
Any questions? Please call us
+36 24/526-026

Industrial Mirrors

TRANSPO 180° MIRROR



Application
Indoor

Material
Acrylic

Fixing
Wall

Warranty
2 years

Our mirror Transpo grants a 180° view so that wide areas can be overseen. The massive construction ensures long-term use.



Photo: Standard mount: telescopic wall mount 30 - 50 cm.
Included in scope of delivery.

Art. No.	Description	Weight	Viewing distance
TRANSPO AC 45	Acrylic, 45 cm	1,4 kg	1 - 2 m
TRANSPO AC 60	Acrylic, 60 cm	1,6 kg	9 - 15 m
TRANSPO AC 80	Acrylic, 80 cm	3,4 kg	15 - 20 m



Industrial Mirrors

MIRROR TRANSPO AC 25

For the safety of forklift-drivers.
Ideal as a rear-view mirror for forklift trucks.



Application
Indoor

Material
Acrylic

Fixing
Screw-on

Warranty
2 years

The mirror increases the safety of both forklift driver and pedestrians. The clear representation facilitates a quick grasp of the situation. Via ball joint mounting bracket, the mirror is adjustable at a 180° angle.



Photo: Application



Photo: Ball joint mount.
Included in scope of delivery.

Art. No.	Description	Weight	Viewing distance
TRANSPO AC 25-S	Acrylic, 25 cm	0,4 kg	1 - 2 m



<https://nagoya.hu/>
Any questions? Please call us
+36 24/526-026

Industrial Mirrors

DOME MIRROR 360°

More safety in your logistic or sales areas



BM 360



Video Dome mirror

Industrial Mirrors

DOME MIRROR 90° & 180°



BM 90

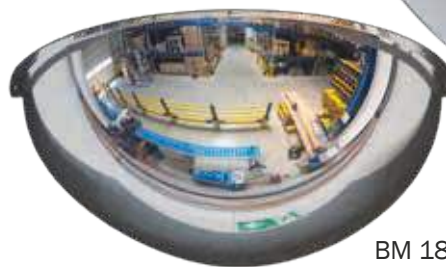

BM 180

Application
Indoor

Material
Acrylic or polycarbonate

Fixing
Chain / Ceiling

Warranty
2 years

Due to the 360° overview, our globe mirror is recommended for surveillance in industrial areas. It helps prevent accidents at crossroads with forklift circulation. It can be hung with chains or directly screwed onto the ceiling.

Our globe mirrors 90° and 180° give a global overview at T-junctions and other hazardous areas. These mirrors make the traffic movements visible in workplaces thus reducing the risk of injuries. The mirrors are directly fixed to the wall or ceiling.

Art. No. BM 360	Description	Weight	Depth	Viewing distance
BM 60-3	Acrylic, ø 60 cm	1,1 kg	29 cm	16 - 20 m
BM 80-3	Acrylic, ø 80 cm	1,5 kg	35 cm	21 - 30 m
BM 90-3	Acrylic, ø 90 cm	2,3 kg	37 cm	30 - 40 m
BM 100-3	Acrylic, ø 100 cm	2,8 kg	38 cm	40 - 50 m
BM 125-3	Acrylic, ø 125 cm	4,2 kg	49 cm	50 - 60 m
Chain				
3095	Chain for BM to ø 100 cm	0,4 kg	Length: 4 x 1000 mm	
3097	Chain for BM ø 125 cm	0,6 kg	Length: 4 x 2500 mm	



Photo: Chain set for ceiling mounting. Included in scope of delivery.

Art. No. BM 180	Description	Weight	Depth	Viewing distance
BM 60-2	Acrylic, 60 cm	0,5 kg	29 cm	10 - 15 m
BM 80-2	Acrylic, 80 cm	1,0 kg	35 cm	15 - 20 m
BM 100-2	Acrylic, 100 cm	1,3 kg	38 cm	25 - 30 m
BM 90				
BM 60-1	Acrylic, 60 cm	0,3 kg	29 cm	10 - 15 m
BM 80-1	Acrylic, 80 cm	0,4 kg	35 cm	15 - 20 m
BM 100-1	Acrylic, 100 cm	0,7 kg	38 cm	25 - 30 m

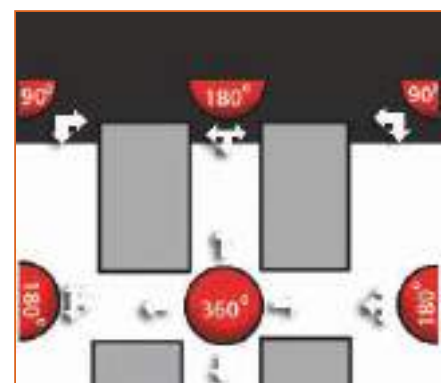

Photo: Use of the different mirror variants



Industrial Mirrors

FLAT MIRROR MADE OF ACRYLIC



Industrial Mirrors

CHECK OUT MIRROR



Application
Indoor

Material
Acrylic

Fixing
Wall / Ceiling

Warranty
2 years

Our multi-use flat mirror was designed for shops and commerce. The mirror is made of acrylic with an aluminum frame. It can be installed directly on the wall or hanging from the ceiling via chains (separately available).

The check out mirror was developed to effectively check "dead areas". The fixing can be adjusted as per your needs.



Photo: Backside flat mirror



Photo: Backside T 3.
Mounting included in scope of delivery.



Photo: Backside T 5, 2 mounting options are included in the scope of delivery

Art. No.	Description	Weight	Viewing distance
IP AC 30 X 40	Acrylic, 30 x 40 cm	0,7 kg	1 - 4 m
IP AC 40 X 60	Acrylic, 40 x 60 cm	1,1 kg	1 - 6 m
IP AC 60 X 80	Acrylic, 60 x 80 cm	2,1 kg	1 - 6 m
IP AC 30 X 100	Acrylic, 30 x 100 cm	1,5 kg	1 - 8 m
IP AC 50 X 100	Acrylic, 50 x 100 cm	1,5 kg	1 - 8 m
IP AC 75 X 100	Acrylic, 75 x 100 cm	3,2 kg	1 - 10 m

Art. No.	Description	Weight	Viewing distance
T 3	Acrylic, 36 x 30 x 30 cm	0,5 kg	1 - 3 m
T 5	Acrylic, 38 x 34 x 34 cm	0,6 kg	1 - 3 m



<https://nagoya.hu/>

Any questions? Please call us
+36 24/526-026

Industrial Mirrors

SPEXI INSPECTION MIRROR

The wheels are reinforced with polyurethane and equipped with bearings for long-term use.

Telescopic aluminum handlebar.

Extendable 40-110 cm.

*one year warranty on the electric parts.



Application
Outdoor and indoor use

Material
Acrylic

Usage
Airports or garage

Warranty
5 years*

Our inspection mirror allows to check even parts of vehicles and machines that are difficult to access. It's equipped with LED lighting and can be used night and day. Its low weight allows for easy handling and carrying.

Now available with matching transport case, fitting all versions for even easier handling and protection of the mirror.



Photo: in the garage



Photo: backside of the mirror
Art. No. IS 35

Art. No.	Description	Weight
IS 20 X 40	with wheels, 20 x 40 cm	1,6 kg
IS 25	round, ø 25 cm	1,0 kg
IS 35	with wheels, round ø 35 cm	1,4 kg
IS-L 20 X 40	with wheels and light, 20 x 40 cm	1,6 kg
IS-L 25	with light, round, ø 25 cm	1,0 kg
IS-L 35	with wheels and light, round ø 35 cm	1,4 kg
IS-BAG	Protective storage and transport case for Dancop inspection mirrors	0,8 kg



Photo: Art. No. IS-BAG

INDUSTRIAL MIRRORS



ED-I Industrial mirrors



Surveillance mirrors EF



The EUvex-mirrors offer a high-quality mirror image at a low entry price. Whether for traffic, industry, or trade: the EUvex safety mirrors are ideally suited to provide a better view of confusing areas. In contrast to the Dancop mirrors, the EUvex mirrors offer less selection and adjustment options and a smaller product range. The EUvex mirrors are neither TÜV-certified nor wind load certified.

Advantages of EUvex mirrors:

- UV-stable
- Fixing bracket for round posts 50-85 mm included in the delivery
- High quality mirror image
- Easy installation



ED traffic mirror



Universal mirrors ED-U



Backside with fixing



Industrial Mirrors

EUvex INDUSTRIAL MIRROR



Application
Indoor

Material
Acrylic

Fixing
Post

Warranty
2 years

The EUvex industrial mirror is equipped with its yellow-black frame heightens the attention in industrial areas, both in- and outdoors. Thus, accidents are effectively reduced, and the facility remains operational.

Material:

The mirror surface is made of PMMA, UV-stable and weather-resistant. The frame is yellow with black warning marks.



Photo: round type



Photo: Backside with standard post fixing. Included in scope of delivery.

Art. No.	Description	Weight	Viewing distance
ED-I 40 x 60	Acrylic, 40 x 60 cm	3,3 kg	9 - 15 m
ED-I 60 x 80	Acrylic, 60 x 80 cm	5,1 kg	15 - 22 m
ED-I 80 x 100	Acrylic, 80 x 100 cm	8,4 kg	22 - 27 m
ED-I 60	Acrylic, round ø 60 cm	3,7 kg	9 - 15 m
ED-I 80	Acrylic, round ø 80 cm	5,2 kg	15 - 22 m
ED-Wandarm	Wall fixing, distance 20 cm	1,9 kg	



Photo: fixing for wall mounting
Art. No. ED-Wandarm. Sold separately.



Industrial Mirrors

EUvex SURVEILLANCE MIRROR



Application
Indoor

Material
Acrylic

Fixing
Post

Warranty
2 years

The EUvex observation mirror can be used to monitor production or sales areas. With its distortion-free reproduction it helps prevent accidents and thefts.

Material:

The mirror surface is made of PMMA for long term use.

Fixing Bracket:

The included flexible fixing bracket as well as the clamp enable easy mounting.



Photo: backside with flexible fixing bracket.
Included in scope of delivery.



Photo: backside with flexible fixing bracket and clamp.
Included in scope of delivery.

Art. No.	Description	Weight	Viewing distance
EF 30	Acrylic, round ø 30 cm	0,8 kg	1 - 4 m
EF 40	Acrylic, round ø 40 cm	0,9 kg	1 - 5 m
EF 50	Acrylic, round ø 50 cm	1,1 kg	5 - 7 m
EF 60	Acrylic, round ø 60 cm	1,5 kg	9 - 15 m



<https://nagoya.hu/>
Any questions? Please call us
+36 24/526-026

Traffic Mirrors

EUvex TRAFFIC MIRRORS



Application
Outdoor and indoor

Material
Acrylic

Fixing
Post

Warranty
2 years

The EUvex traffic mirror increases safety on roads and premises. Due to its robust design it is suitable for long term outdoor use. The type RA2 reflectors ensure good visibility, even in bad weather conditions.

Material:

The EUvex mirror surface is made of PMMA and equipped with red reflectors (Type RA2) on a white frame. It is UV-stable and weather-resistant.



Photo: round type



Photo: Back side with standard post fixing. *Included in scope of delivery.*

Art. No.	Description	Weight	Viewing distance
ED 40 x 60	Acrylic, 40 x 60 cm	4,3 kg	9 - 15 m
ED 60 x 80	Acrylic, 60 x 80 cm	6,8 kg	15 - 22 m
ED 80 x 100	Acrylic, 80 x 100 cm	10,9 kg	22 - 27 m
ED 60	Acrylic, round ø 60 cm	5,0 kg	9 - 15 m
ED 80	Acrylic, round ø 80 cm	7,4 kg	15 - 22 m
ED-Wand-arm	Wall fixing, distance 20 cm	1,9 kg	



Photo: fixing for wall mounting
Art. No. ED-Wandarm. *Sold separately.*



Traffic Mirrors

EUvex UNIVERSAL MIRRORS



Application
Outdoor and indoor

Material
Acrylic

Fixing
Post

Warranty
2 years

The EUvex universal mirror is equipped with a white frame and very versatile.

Material

The EUvex universal mirror surface is made of PMMA, UV-stable and weather-resistant.



Photo: Round version



Photo: Back side with standard post fixing. *Included in scope of delivery.*

Art. No.	Description	Weight	Viewing distance
ED-U 40 x 60	Acrylic, 40 x 60 cm	1,8 kg	9 - 15 m
ED-U 60 x 80	Acrylic, 60 x 80 cm	4,0 kg	15 - 22 m
ED-U 80 x 100	Acrylic, 80 x 100 cm	6,6 kg	22 - 27 m
ED-U 60	Acrylic, round \varnothing 60 cm	2,0 kg	9 - 15 m
ED-U 80	Acrylic, round \varnothing 80 cm	4,2 kg	15 - 22 m
ED-Wandarm	Wall fixing, distance 20 cm	1,9 kg	



Photo: fixing for wall mounting

Art. No. ED-Wandarm. *Sold separately.*



<https://nagoya.hu/>

Any questions? Please call us

+36 24/526-026

IMPACT PROTECTION MADE OF POLYURETHANE





IMPACT PROTECTION MADE OF SOLID POLYURETHANE

Why use Polyurethane?

Unlike steel, polyurethane needs no reparation after a collision, as it is non-corrosive.

The material is colored all the way through. Therefore, the product is highly recommended for the food industry.

Available in following versions:

- Bollards in three diameters.
- Beams in three lengths.
- Hoop guards in seven sizes.



Discover
all products



Scan me!

Advantages of Rambowl products:

- One product for outdoor and indoor use
- Extremely impact resistant
- Red reflective warn marking and black stripes for better visibility
- Additionally, steel reinforced for higher stability
- Suitable for use in the food industry
- Non-corrosive
- Fixing via base plate with floor anchors



Photo: Art. No.: P30-50



<https://nagoya.hu/>
Any questions? Please call us
+36 24/526-026

PROTECTION BOLLARDS

The bollards provide massive protection for machines, rack installations and entrance gates. The yellow coloring in combination with the red and black reflective stripes ensure high level of visibility.

Three different diameters to cover your needs.

Fixing material available separately.
For indoor and outdoor use.

Bollard made of polyurethane, height 1000 mm, with reflecting stripes



Art. No.	Description	Diameter	Baseplate size	Weight
P50-50	Bollard	ø 90 mm	200 x 200 x 25 mm	11,0 kg
P50-60	Bollard	ø 159 mm	250 x 200 x 25 mm	27,7 kg
P50-70	Bollard	ø 273 mm	320 x 320 x 25 mm	80,2 kg
PFIX 1	Fixing set, 4 floor anchors, galvanized, 95 mm length, ø 10 mm			0,24 kg
PFIX2	Fixing set, 4 floor anchors, stainless steel, 95 mm length, ø 10 mm			0,24 kg

PROTECTION BEAMS

The beams are the perfect solution for impact protection and visibly separate forklift traffic routes from pathways.

Fixing material available separately.
For indoor and outdoor use.

Beam made of polyurethane, ø 80 mm, with reflecting stripes



Art. No.	Description	Diameter	Length	Weight
P60-10	Bar	ø 80 mm	400 mm	3,4 kg
P60-20	Bar	ø 80 mm	800 mm	6,2 kg
P60-30	Bar	ø 80 mm	1200 mm	8,8 kg
PFIX 1	Fixing set, 4 floor anchors, galvanized, 95 mm length, ø 10 mm			0,24 kg
PFIX2	Fixing set, 4 floor anchors, stainless steel, 95 mm length, ø 10 mm			0,24 kg

HOOP PROTECTION GUARDS

The hoop protection guards are the perfect solution for protecting buildings, machines, and inventory. The different sizes offer the right product for each type of use.

Fixing material is separately available.
For indoor and outdoor use.

Hoop protection guard made of polyurethane, base plate 140 x 140 x 20 mm, Ø 80 mm, with reflecting stripes

Art. No.	Description	Height	Length	Weight
P30-10	Hoop protection guard	350 mm	375 mm	7,4 kg
P30-20	Hoop protection guard	350 mm	750 mm	9,9 kg
P30-30	Hoop protection guard	350 mm	1000 mm	11,6 kg
P30-40	Hoop protection guard	600 mm	750 mm	14,1 kg
P30-50	Hoop protection guard	600 mm	1000 mm	15,5 kg
P30-60	Hoop protection guard	1200 mm	750 mm	22,5kg
P30-70	Hoop protection guard	1200 mm	1000 mm	24,3 kg
PFIX3	Fixing set, 8 floor anchors, galvanized, 95 mm length, Ø 10 mm			0,48 kg
PFIX 4	Fixing set, 8 floor anchors, inox, 95 mm length, Ø 10 mm			0,48 kg

Photo: Art. No.: P30-50



Photo: Art. No.: P30-10



Photo: Art. No.: P30-20



Photo: Art. No.: P30-0



Photo: Art. No.: P30-60



Photo: Art. No.: P30-50



Photo: Art. No.: P30-40



Photo: Art. No.: P30-30



<https://nagoya.hu/>
Any questions? Please call us
+36 24/526-026

WARNING AND PROTECTION PROFILES



Profile Type A



Profile Type B



Profile Type R30



Profile Type F

WARNING AND PROTECTION PROFILES

Warning and protection profiles are very versatile and can be used on machines, vehicles, walls, corners or in transportation lanes. They are a fail-safe measure to protect both expensive equipment and employees from accidents.

The warning and protection profiles are easily attached due to strong adhesive strips. If necessary, they can be cut to size. Once the protective foil has been removed, the profile only needs to be pressed onto the clean surface for a short amount of time.

A strong, light- and aging-resistant acrylate glue is used on all adhesive profiles (21 N/25 mm).

The warning and protection profiles are available as 1 m pieces, 5 m rolls or in customized lengths (starting with 1 m, exact to 10 cm).



Discover
all products



Scan me!

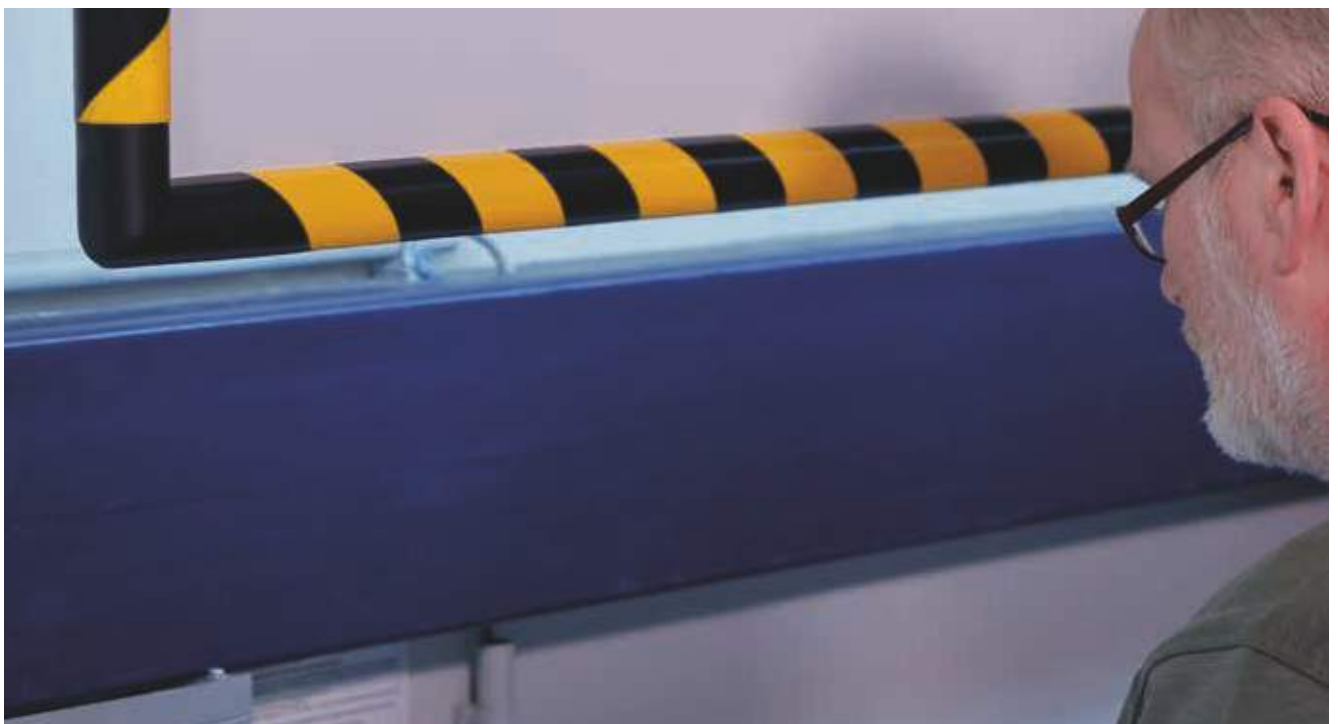

<https://nagoya.hu/>
Any questions? Please call us
+36 24/526-026

WARNING AND PROTECTION PROFILES

The warning and protection profiles are available as 1 m pieces, 5 m rolls or in customized lengths (starting with 1 m, exact to 10 cm).

Item	Corner protection					
Profile mm						
	Type A	Type A+	Type AA	Type E	Type H	Type H+
1m-piece Art. No.	10010	11013	11010	10015	11110	11014
Roll Art. No.	10020, 5 m roll	11023, 3 m roll	11020, 5 m roll	10024, 5 m roll	11120, 5 m roll	not available
Running meters Art. No.	10040	11043	11040	10044	11140	not available
Weight / 1,0 m	0,4 kg	0,5 kg	0,5 kg	0,2 kg	0,4 kg	0,7 kg
Fixing	self-adhesive					



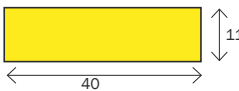
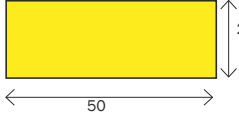
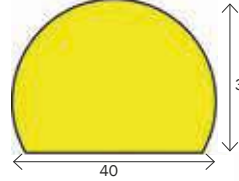
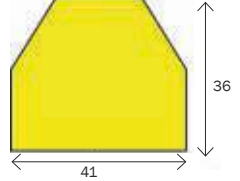

Item	Pipe protection		Edge protection		Edge protection
Profile mm					
	Type R30	Type R50	Type B	Type BB	Type G
1m-piece Art. No.	10017	10014	10011	11011	10019
5 m roll Art. No.	10027	not available	10021	11021	10026
Running meters Art. No.	10047	not available	10041	11041	10046
Weight / 1,0 m	0,4 kg	0,5 kg	0,6 kg	0,6 kg	0,4 kg
Fixing	self-adhesive		to clip on		self-adhesive

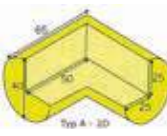

Item	Surface protection			
Profile mm				
	Type F	Type D	Type C	Type CC
1m-Piece Art. No.	10016	10013	10012	11012
5 m roll Art. No.	10025	10023	10022	11022
running meters Art. No.	10045	10043	10042	11042
Weight / 1,0 m	0,3 kg	0,5 kg	0,5 kg	0,6 kg
Fixing	self-adhesive			

CORNER PROTECTION

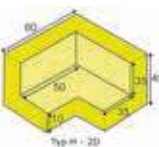
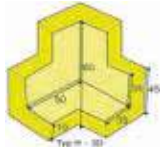
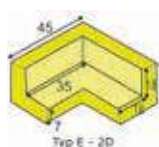

Available in versions for profiles type A, type H and type E, black						
Profile mm						
	Corner Type A, 2D	Corner Type A, 3D	Corner Type H, 2D	Corner Type H, 3D	Corner Type E, 2D	Corner Type E, 3D
Art. No. black	10810	10811	10814	10815	10812	10813
Fixing	self-adhesive					





NagoyaKft.

2330 Dunaharaszti
Irinyi János u. 3/a.

Tel.: +36 24/526-026

E-mail: nagoya@nagoya.hu

Szabó Zsolt Termékmenedzser

Tel: 00 36 70 503 8620

E-mail: szabo.zsolt@nagoya.hu

